



**2012-2018 Jeep Wrangler JL 3.6L  
Supercharger System  
Installation Manual**

**Important Notes:**

- If you have any questions or concerns with this kit please call: 732-240-3696
- The use of **MINIMUM** 91 Octane Fuel is mandatory.
- The use of fuel additives is not recommended. There is a possibility that these chemicals can damage your engine and cause drivability issues with your vehicle.

**BEFORE BEGINNING INSTALLATION SEND THE ECM BACK TO HAMBURGERS SUPERCHARGERS USING THE INCLUDED SHIPPING LABEL AND BOX. THIS WILL ALLOW TIME FOR HAMBURGERS SUPERCHARGERS TO GET THE ECM BACK TO YOU ASAP.**

**NOTE: IF YOU PURCHASED A "TUNER KIT" THERE IS NO NEED TO REMOVE THE ECU.**

**WARNING: Hamburgers Superchargers Inc. recommends allowing the vehicle to cool (not running) for two hours before beginning installation.**

**WARNING: To avoid the chance of electrical shock or damage to your vehicle's electrical system, disconnect both the negative and positive battery leads (in that order) at the battery.**

**FUEL SYSTEM PRESSURE RELEASE**

**WARNING:**

The fuel system is under constant high pressure even with engine off. Until the fuel pressure has been properly released from the system, do not attempt to open the fuel system. Do not smoke or use open flames/sparks when servicing the fuel system. Wear protective clothing and eye protection. Make sure the area in which the vehicle is being serviced is in a well ventilated area and free of flames/sparks. Failure to comply may result in serious or fatal injury.

1. Remove the fuel pump relay from the power distribution center (PDC). The relay location label can be found on the underside of the PDC cover.
2. Start and run the engine until it stalls.
3. Attempt restarting engine until it will no longer run.
4. Turn ignition to the OFF position.
5. Return fuel pump relay to the Power Distribution Center (PDC).
6. Disconnect the negative battery terminal cable from the battery.
7. Disconnect the negative lugs on the inner fender next to the battery.



8. Remove the 2 connectors from the ECM as shown below. Then the 3 bolts holding the ECM to the bracket. Pack the ECM in the pre paid box to send back to Hamburgers Superchargers Inc.



9. Remove the front grill, lower grill shroud, skid plate, and engine cover as shown below.

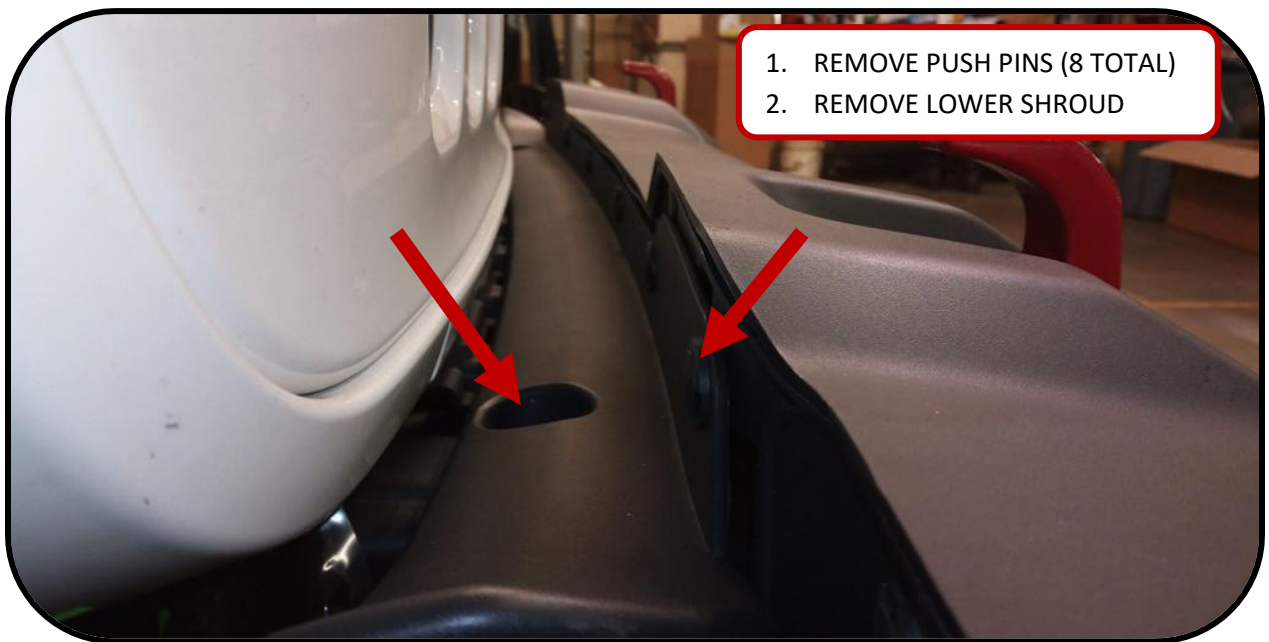
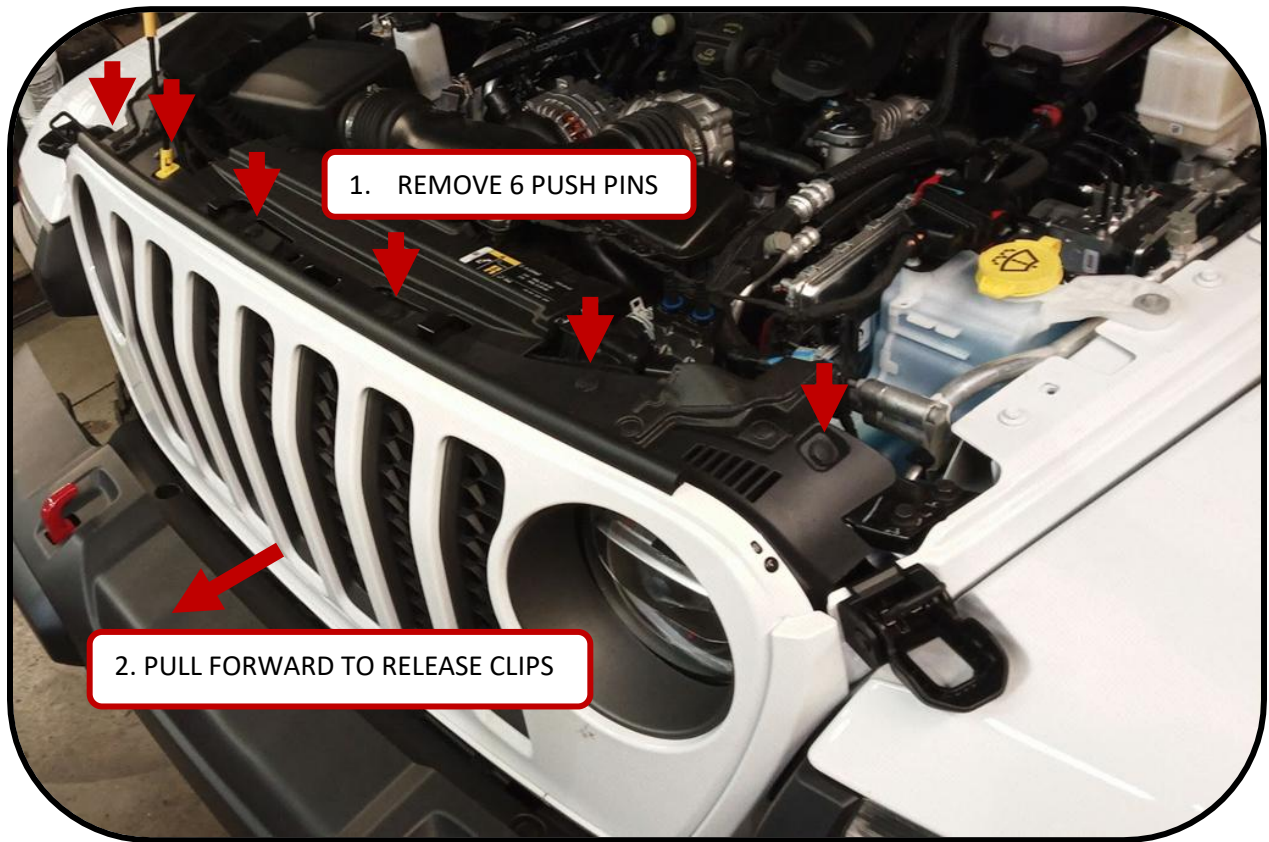

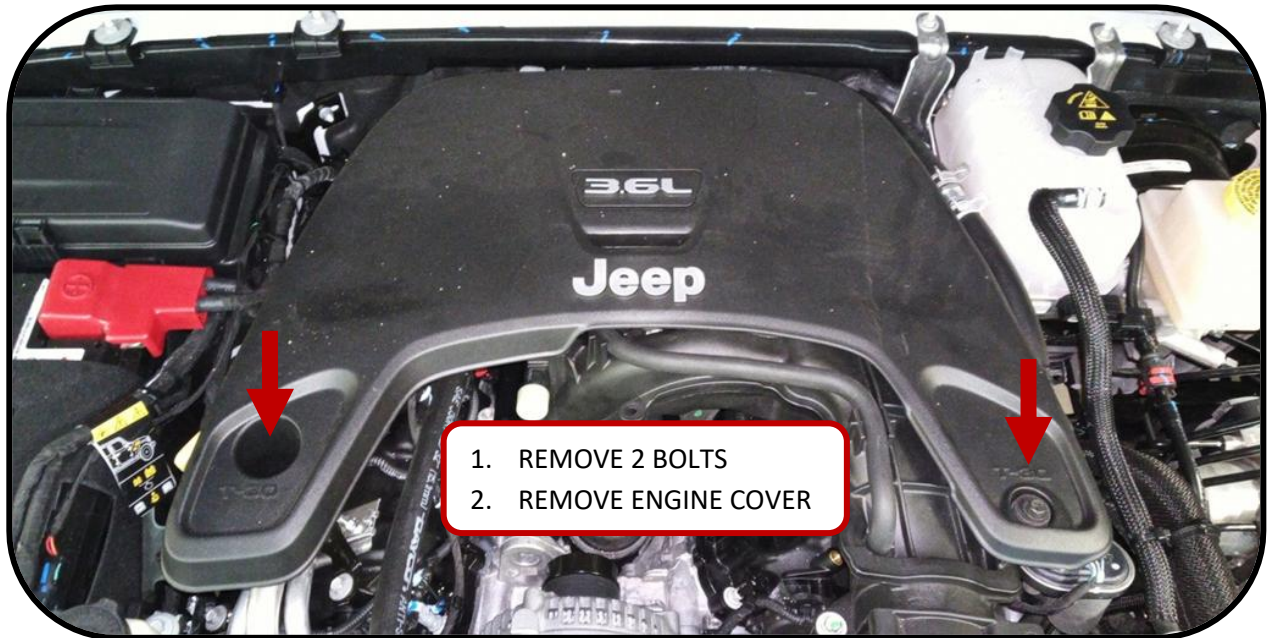

10. Disconnect the electrical connector from the Inlet Air Temperature (IAT) sensor.
11. Loosen the clamp at the throttle body and the air cleaner box.
12. Disconnect the fresh air makeup hose from the air inlet tube.
13. Remove the two bolts from the air inlet tube.
14. Disengage the air inlet tube from the throttle body and air cleaner box and remove the tube.
15. Remove the bolt securing the factory air box on the fender well and remove the factory air box.

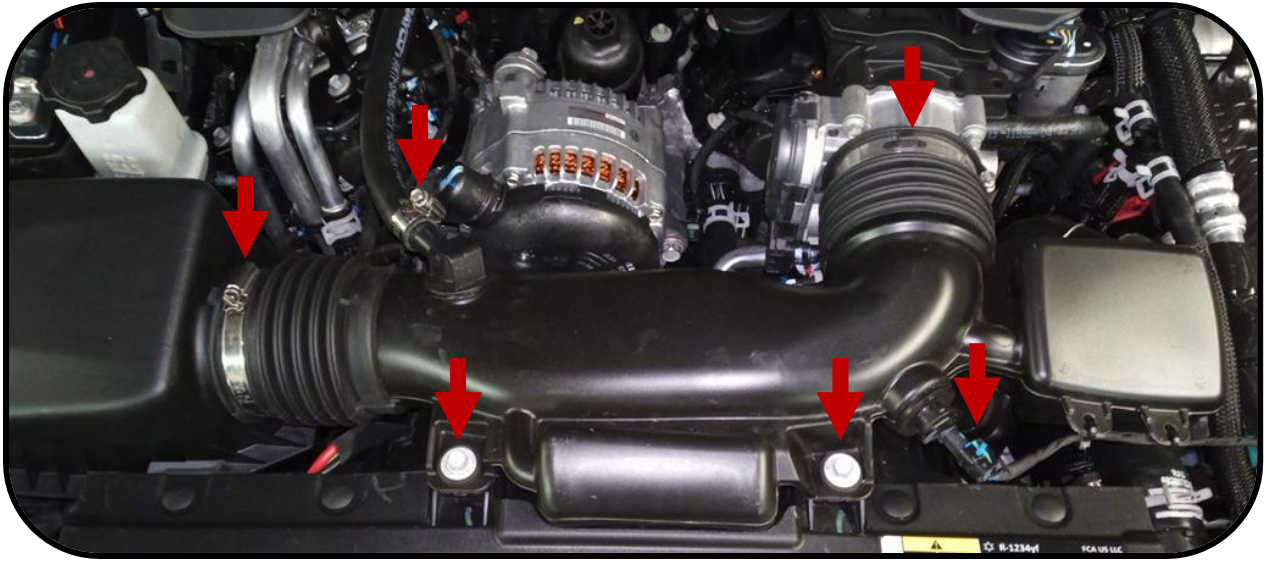

16. Remove the Intake Air Temperature (IAT) sensor from the intake air tube. Gently lift the small plastic release tab (3) and rotate the sensor about 1/4 turn counter-clockwise to remove the sensor from the inlet air tube. The IAT sensor O-ring (2) can be reused. Put the sensor in a safe place as it will be re-used later in the new charge tube.

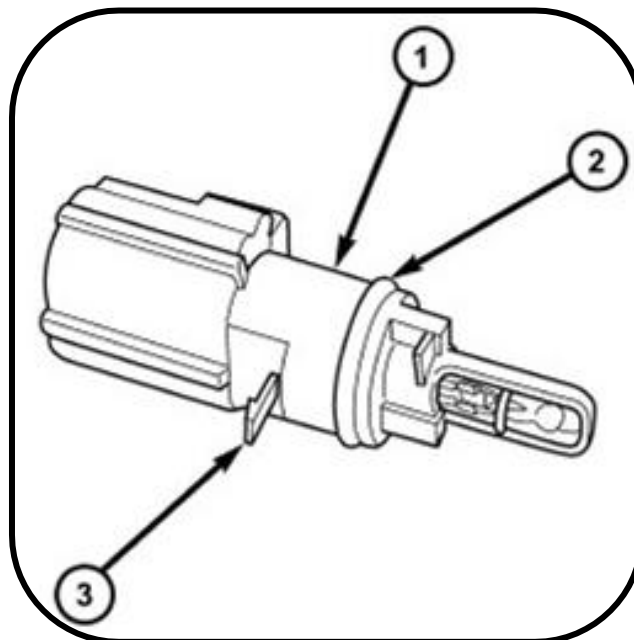

17. Remove the Exhaust Gas Recirculation (EGR) valve and disconnect the brake booster vacuum hose and PCV foul air tube from the intake manifold.

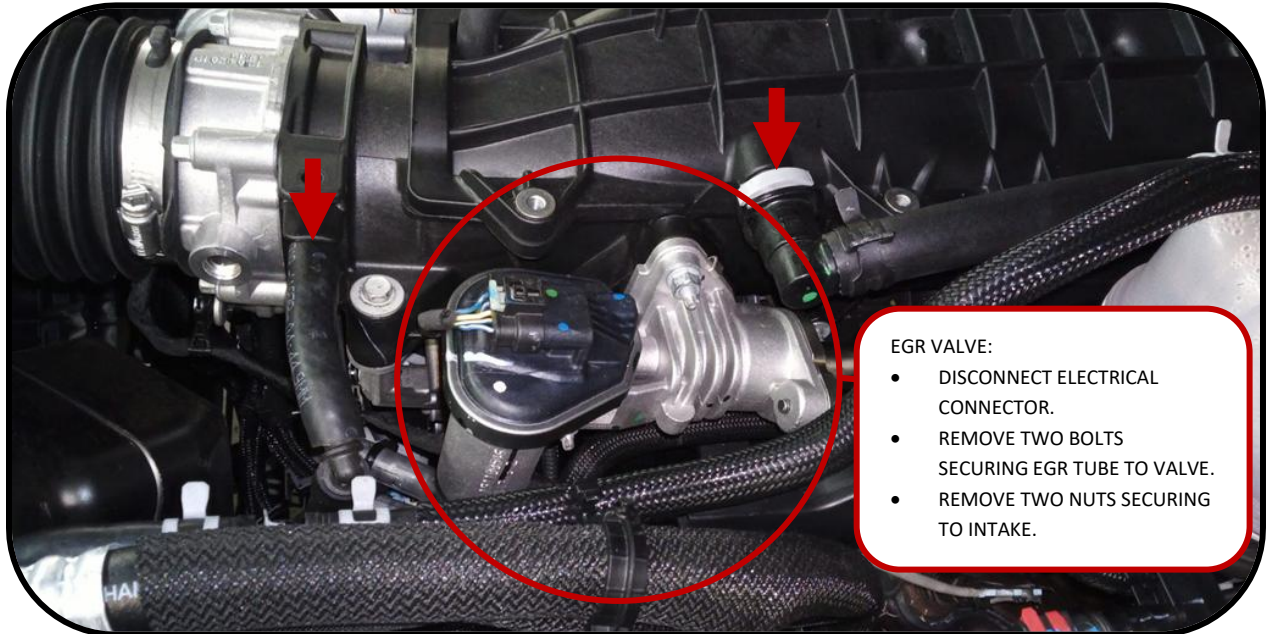

18. Remove the intake manifold support bracket nuts from the driver's side of the intake.

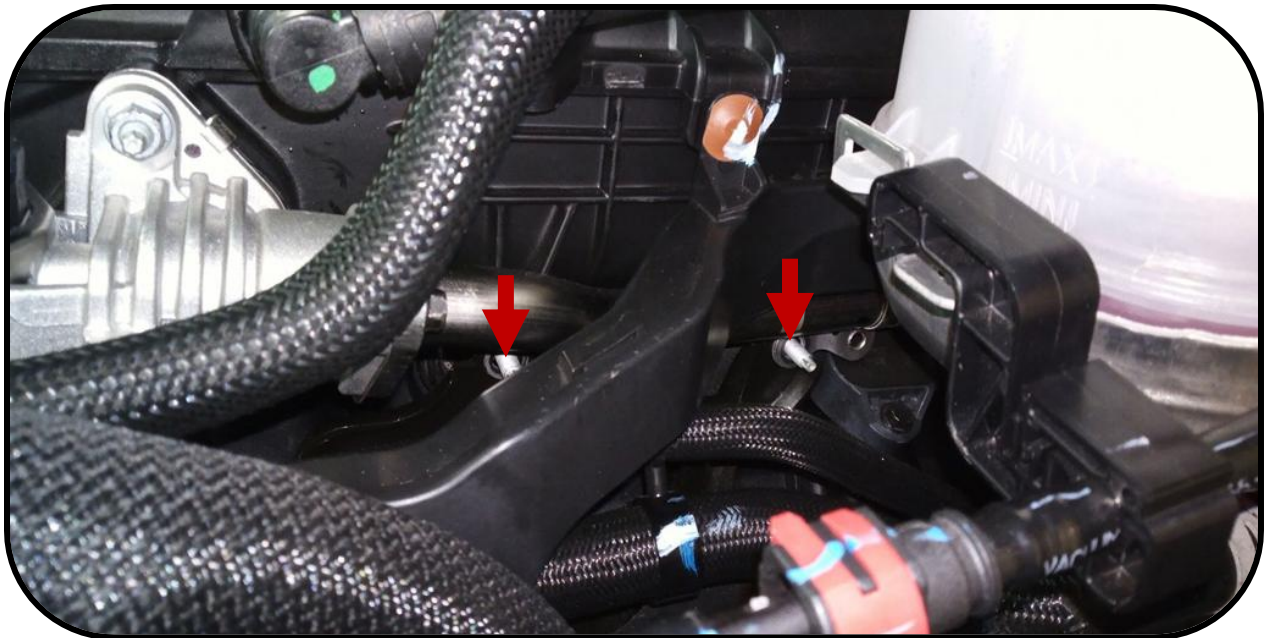



19. Disconnect the electronic throttle body connector and any retainers securing the wiring harness to the intake manifold.

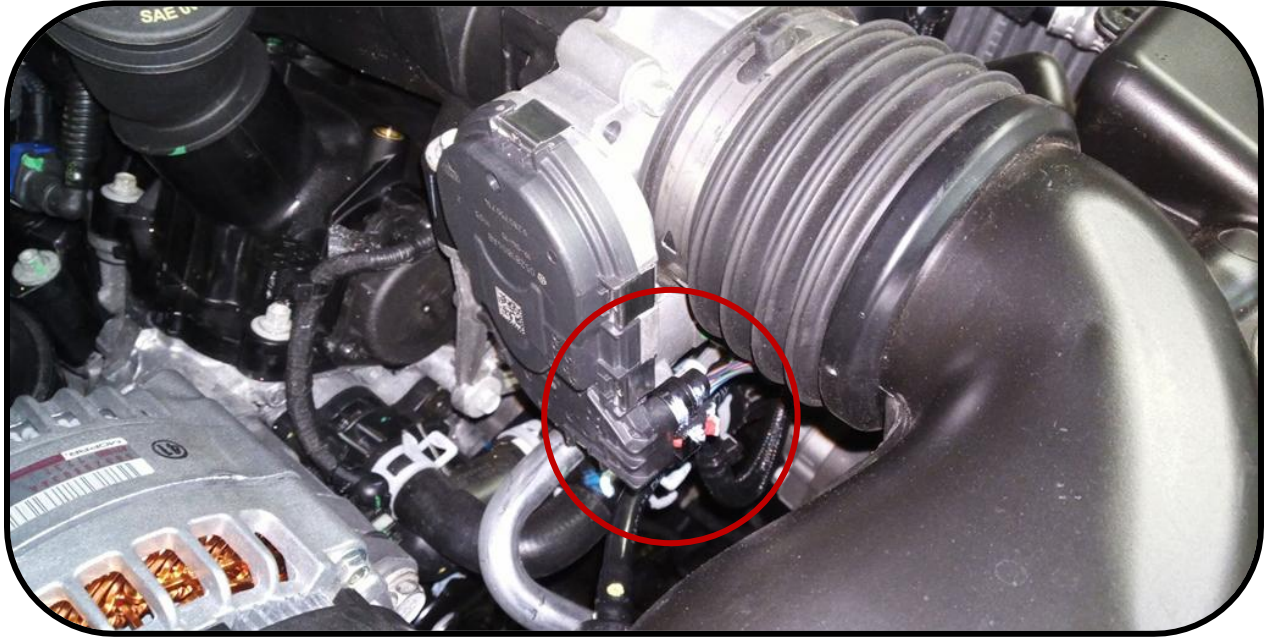

20. Disconnect the Manifold Absolute Pressure (MAP) sensor electrical connector. Disengage any electrical harness retainers attached to the intake manifold.



21. Disconnect the Purge Valve electrical connector and hose from the Purge Valve. Disengage any electrical harness retainers attached to the intake manifold.

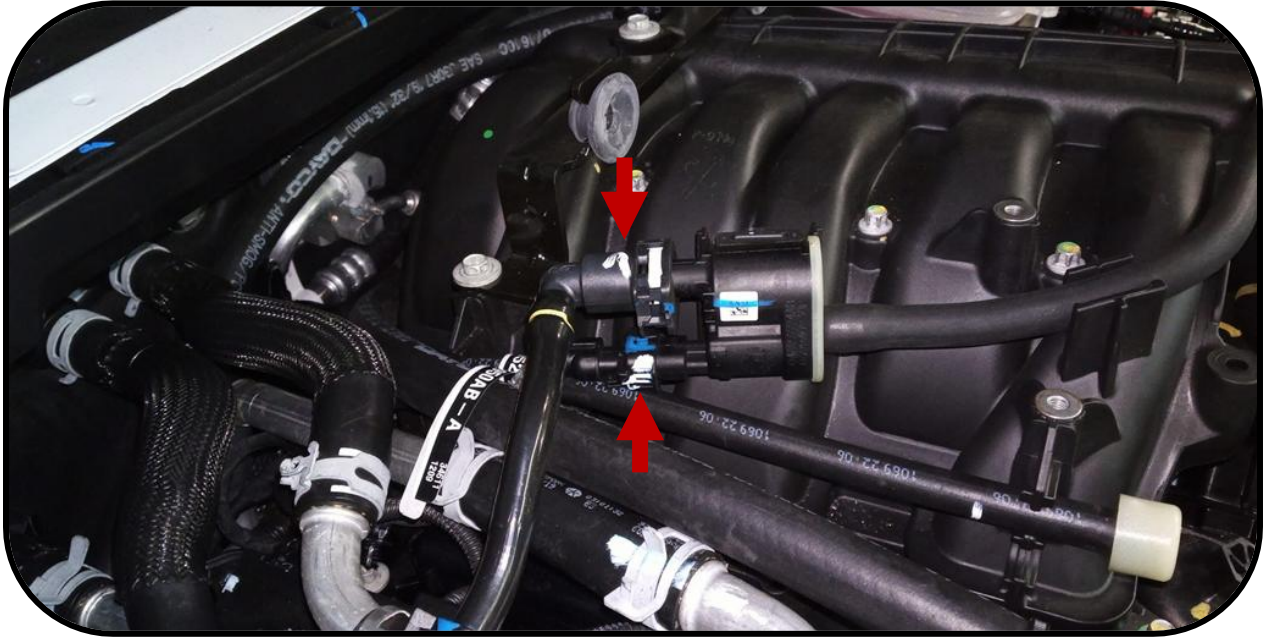

22. Next remove the front intake manifold support bolts.

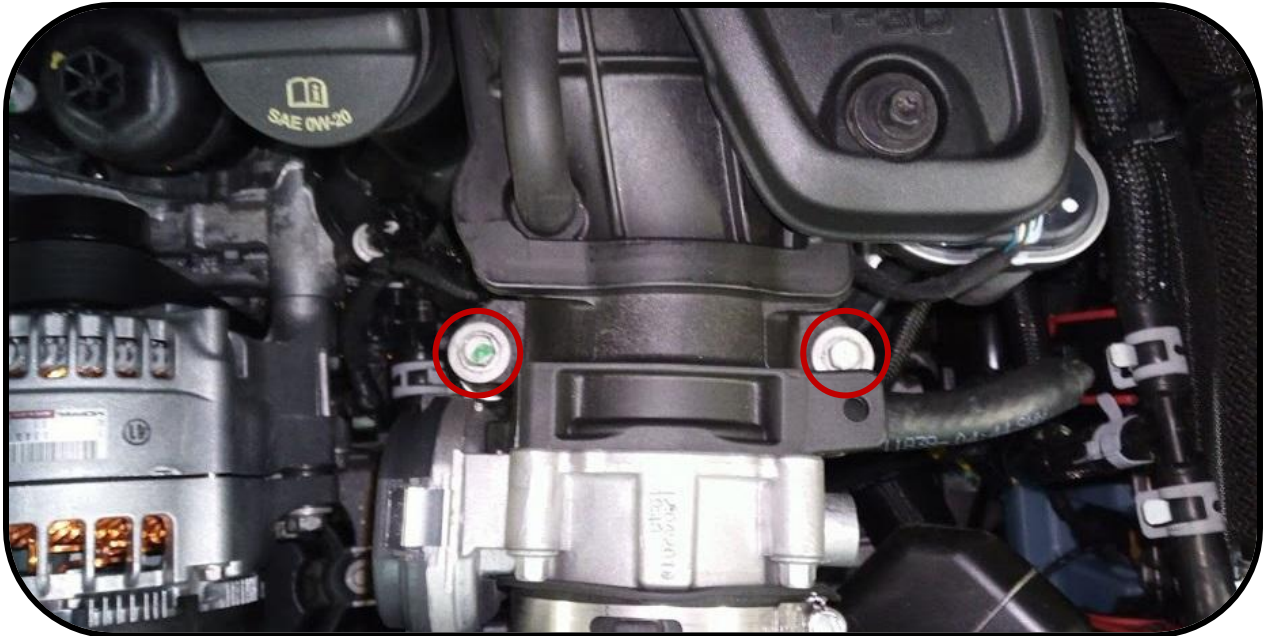

23. Remove seven upper intake manifold bolts and remove the upper intake manifold.

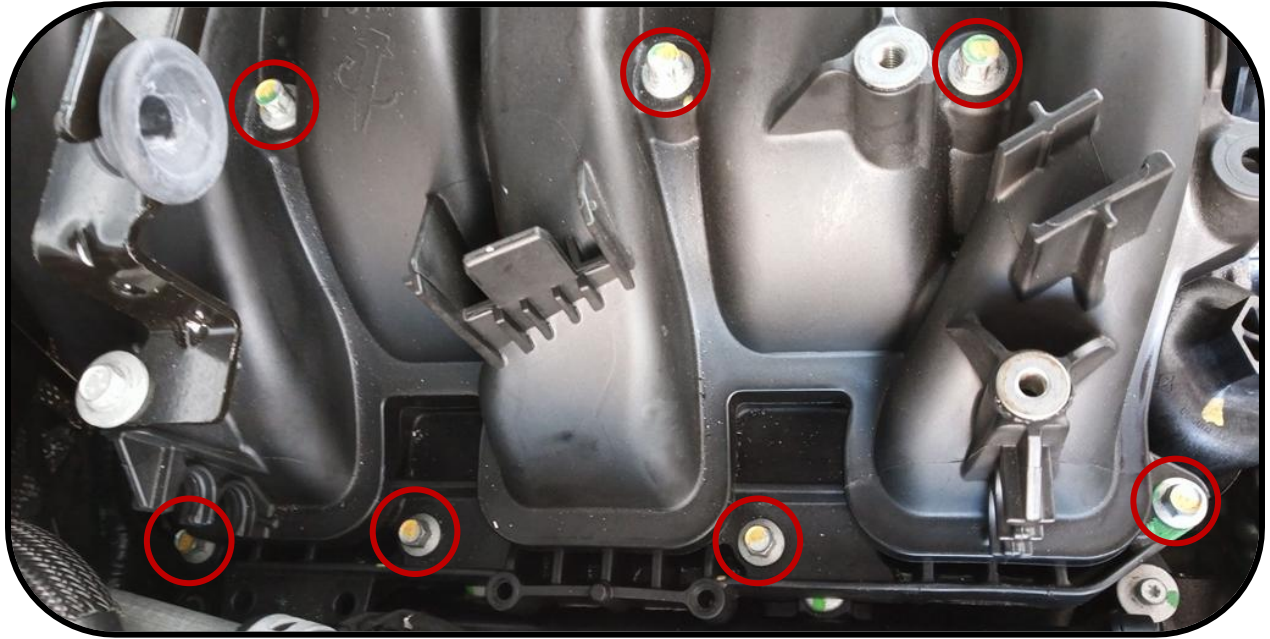

24. Cover the open intake ports to prevent debris from entering the engine.

25. Remove the insulator from the LH cylinder head cover.

26. Disconnect the fuel injector electrical connectors.

27. Disconnect the fuel supply hose from the fuel rail.

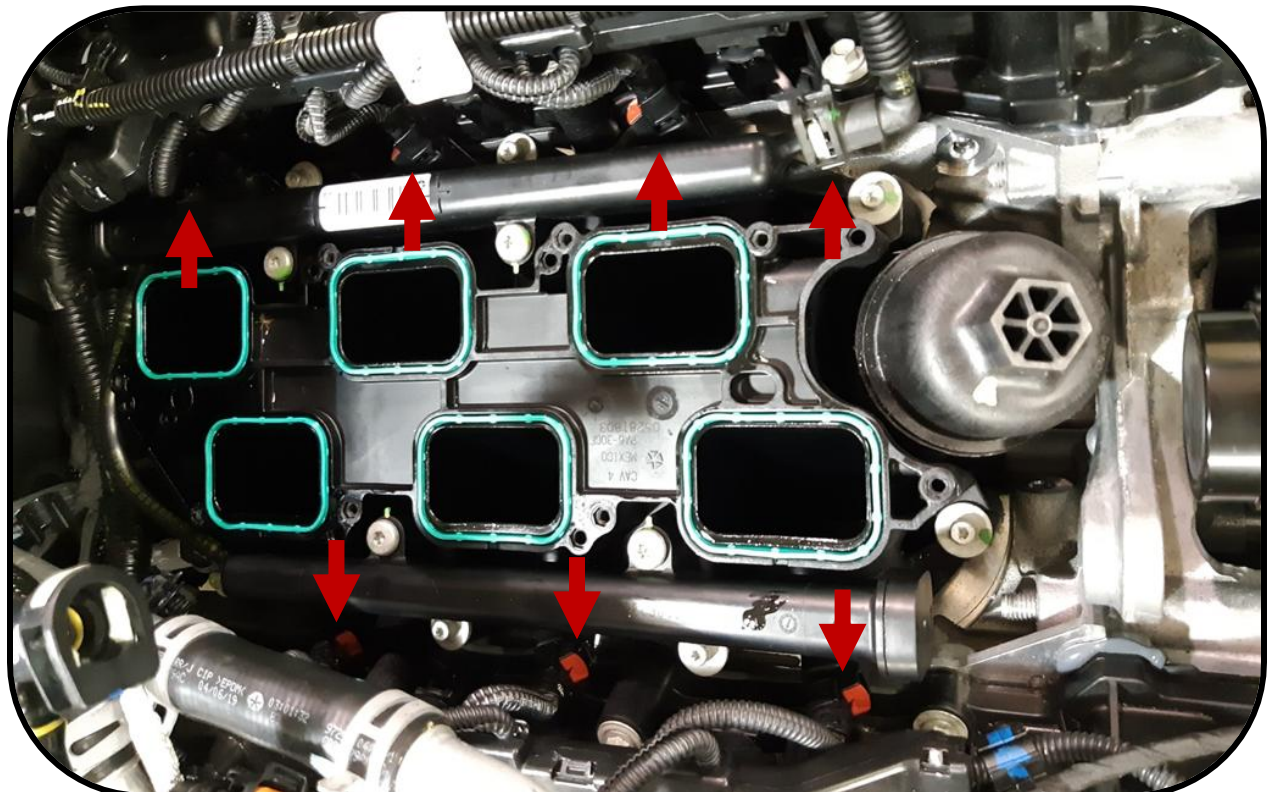

28. Remove the four T30 bolts from the fuel rail.

29. Lift the fuel rail and the fuel injectors from the lower intake manifold.

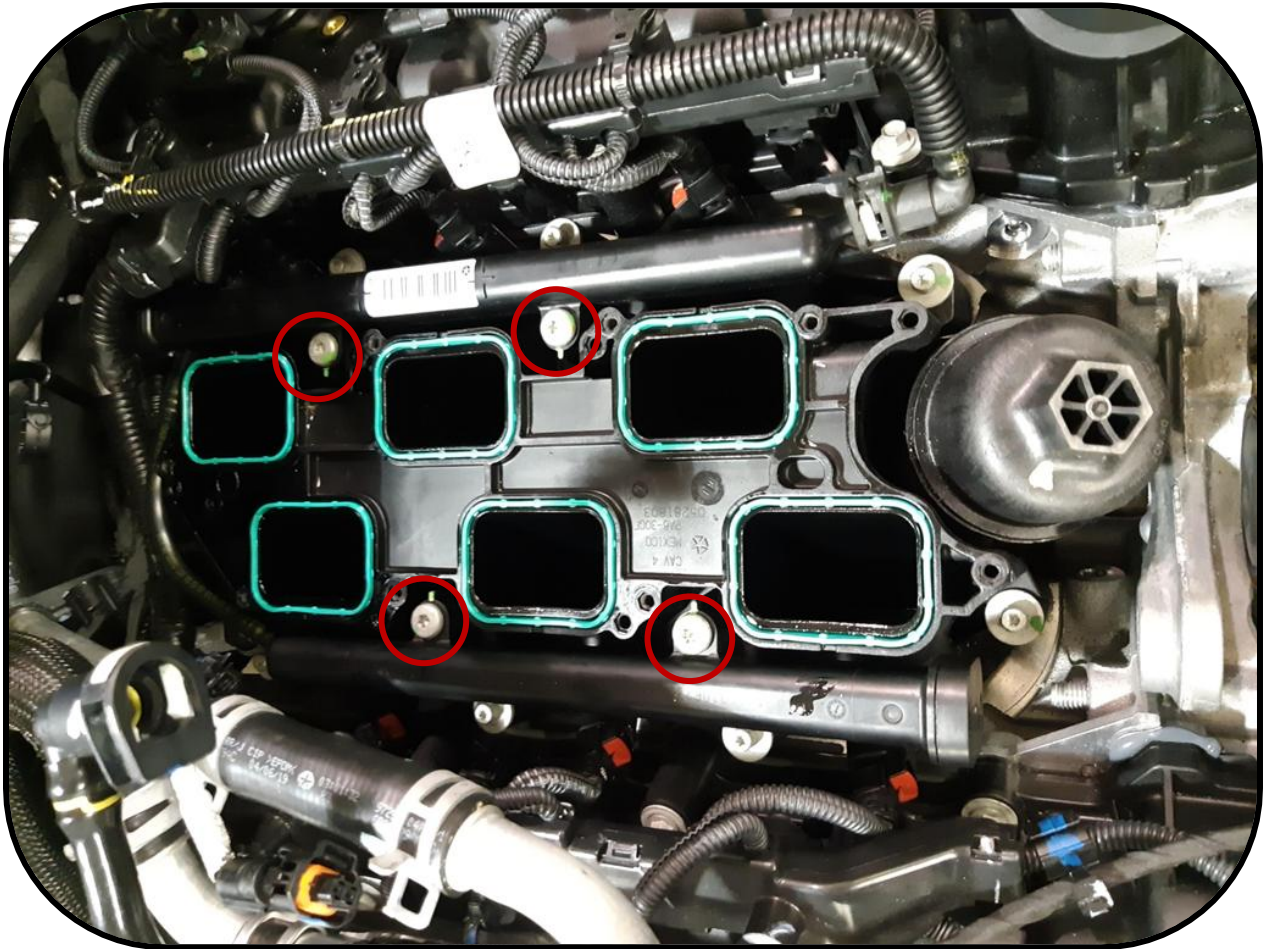

**CAUTION:**

The left and right fuel rails are replaced as an assembly. Do not attempt to separate the rail halves at the connector tube. Due to the design of this tube, it does not use any clamps. Never attempt to install a clamping device of any kind on the tube. When removing the fuel rail assembly for any reason, be careful not to bend or kink the tube.

**CAUTION:**

When removing the fuel rail from the lower intake manifold, one or more fuel injectors may remain in the intake manifold resulting in residual fuel spilling onto the engine from the fuel rail.

30. Remove any remaining fuel injectors from the lower intake manifold.

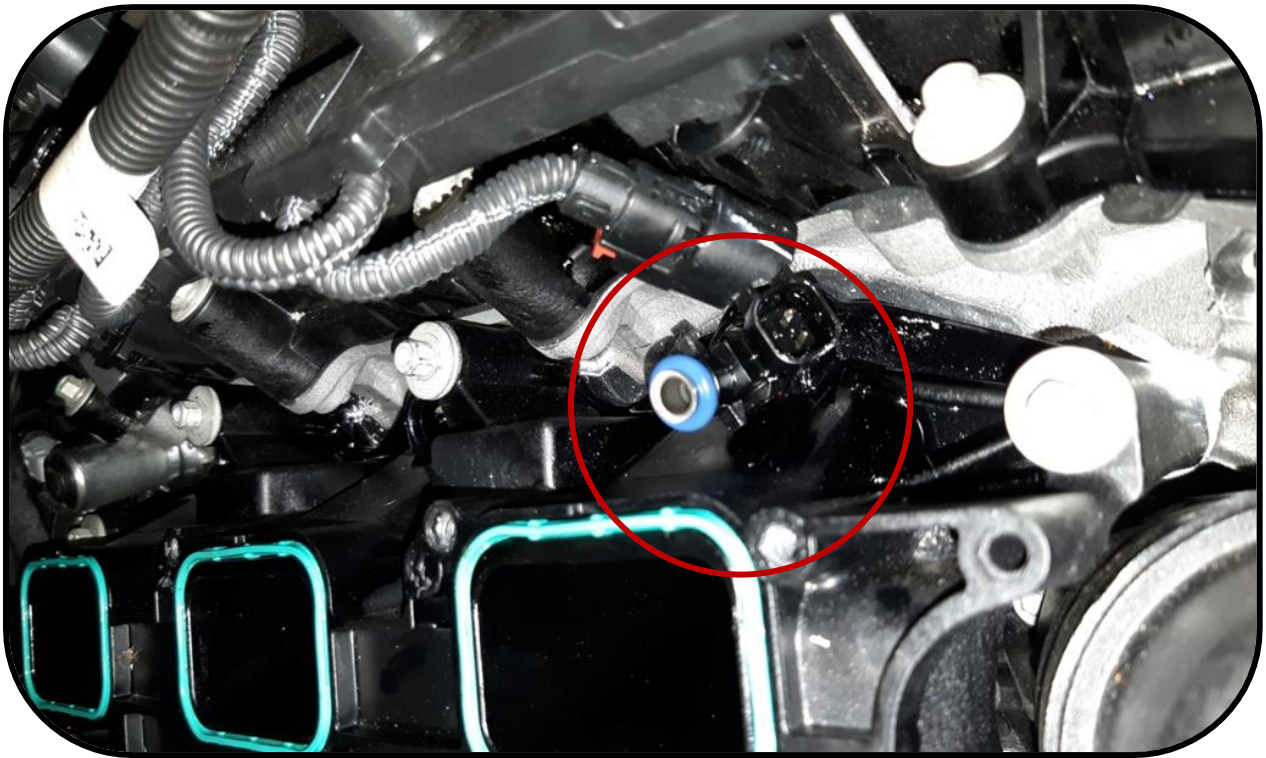

31. Remove the lower o-rings of the supplied injectors and replace with the supplied red o-rings.



32. Apply a small amount of grease to the o-rings of the supplied injectors. Insert the injectors into the fuel rail and push down until they are fully seated. Make sure the injector connector is facing away from the center of the engine.
33. Align the fuel rail with the manifold and push the rail down until the injectors are seated into the manifold. The fuel rail mounting holes will sit flush with the lower intake manifold.
34. Reinstall the T-30 screws that hold down the fuel rails and reconnect the fuel supply tube.
35. If you purchased the required colder spark plugs with this kit, remove the coil packs and replace the factory spark plugs now.
36. Reinstall the intake manifold using the new gaskets and torque to 7-9Nm.
37. Reinstall the EGR Valve.
38. Install the new MAP sensor, it will be necessary to grind the stop on the intake manifold and grind the alignment tab on the new sensor, see photo.



39. Moving to the front of the engine, disconnect the electrical connector and vacuum tube on the brake booster vacuum pump. Remove the two bolts securing the pump bracket to the engine and remove the pump.

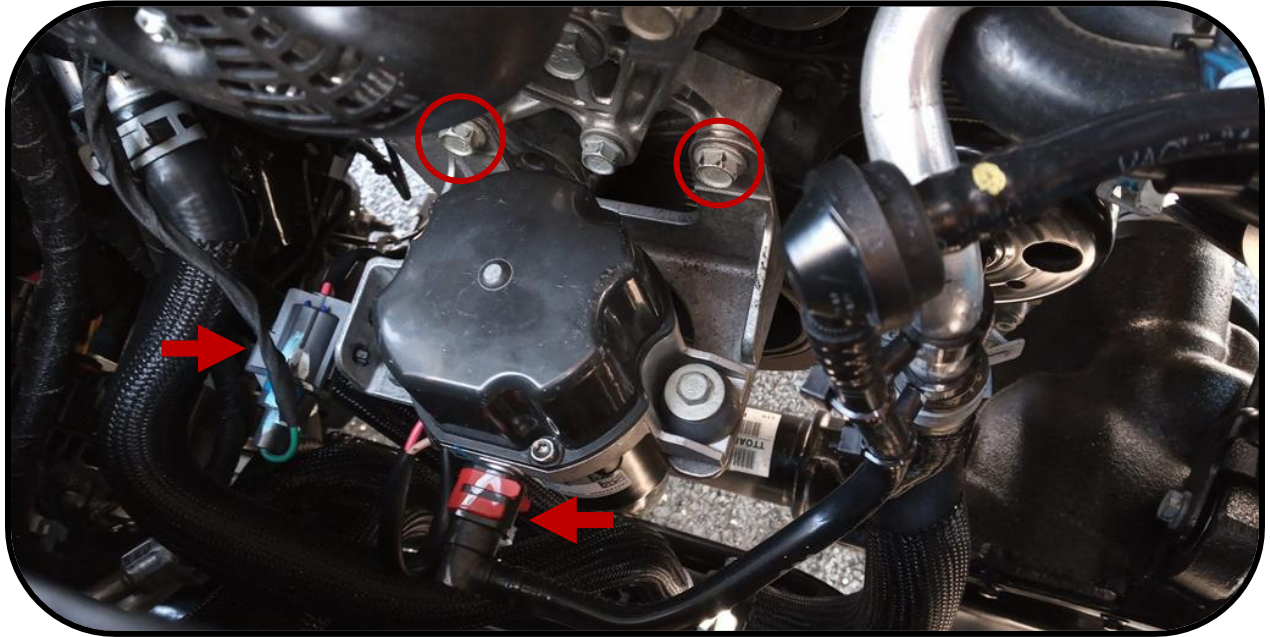

40. Remove the stock accessory belt by using a ½" drive breaker bar on the tensioner. Once the tensioner is compressed, remove the belt.

41. Remove the positive power cable from the alternator and unclip the electrical connector from the alternator.

42. Remove the bolts holding the alternator to the engine. There are four bolts total. See photo below. These bolts will NOT be reused.

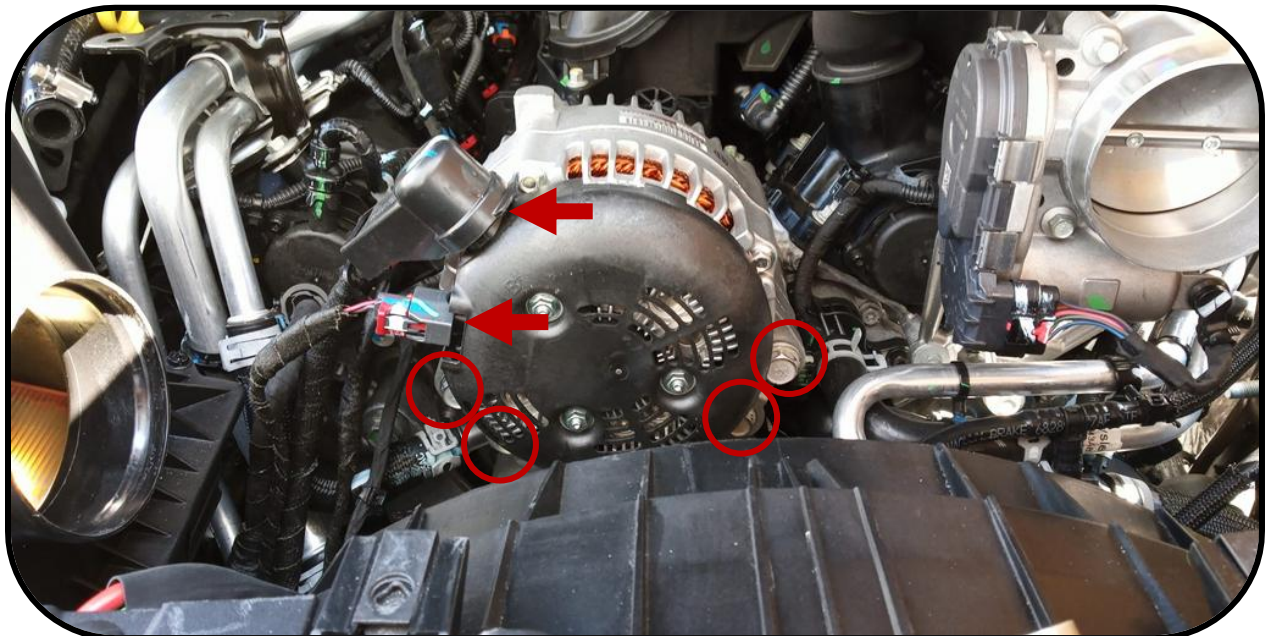

43. Remove the factory alternator bracket from the front of the engine.

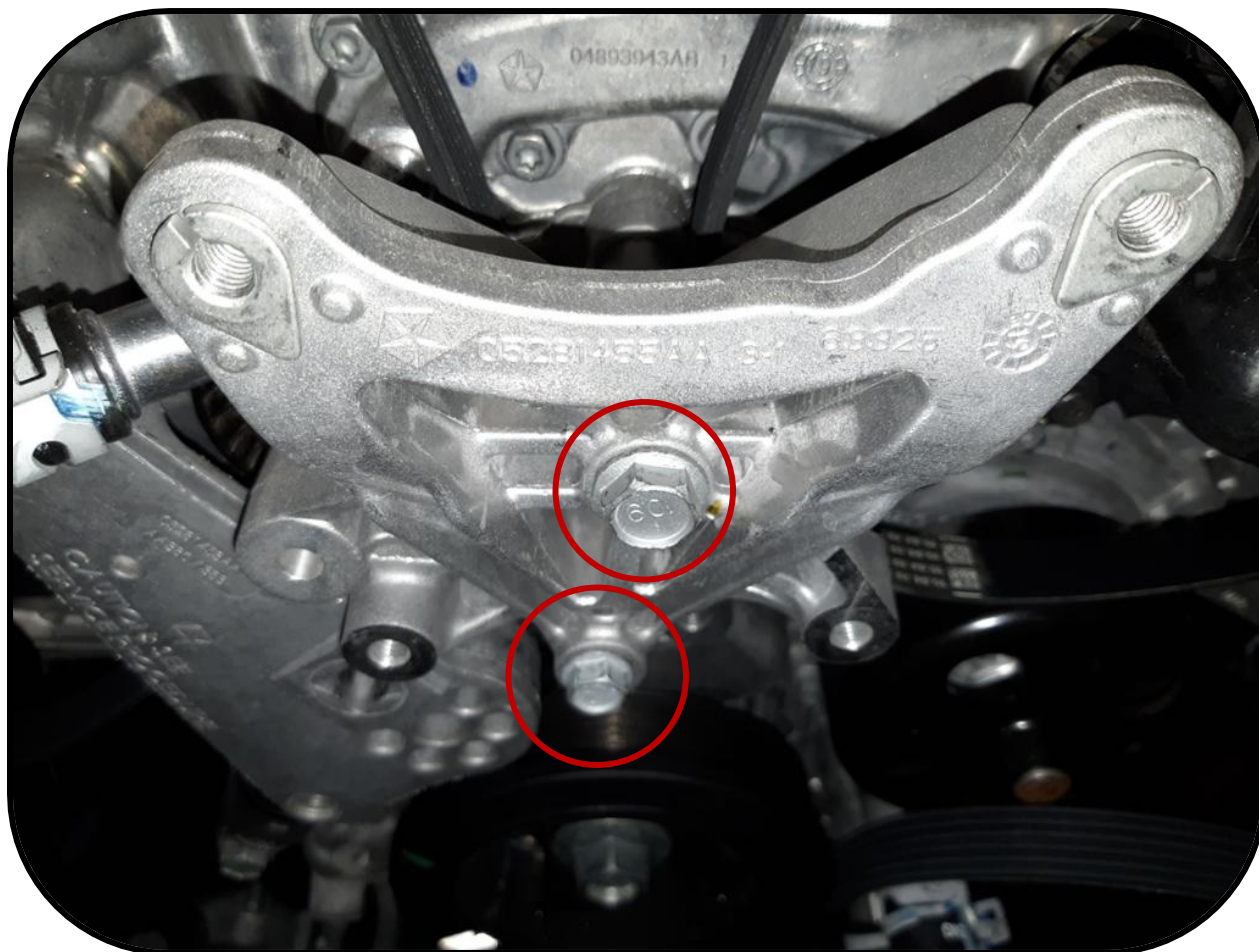



44. The alternator will be relocated to the bottom driver side of the engine as shown below. Utilize the provided alternator brackets and hardware. First preassemble the new alternator bracket set as shown in the pictures below using the two supplied M10x50MM bolts and torque these bolts to 40 ft-lbs.



45. Install the new alternator bracket. There are three bolts that hold the bracket to the engine. Torque all three bolts to 25 ft-lbs. Torque the two bolts that hold the alternator to the new bracket to 40 ft-lbs.

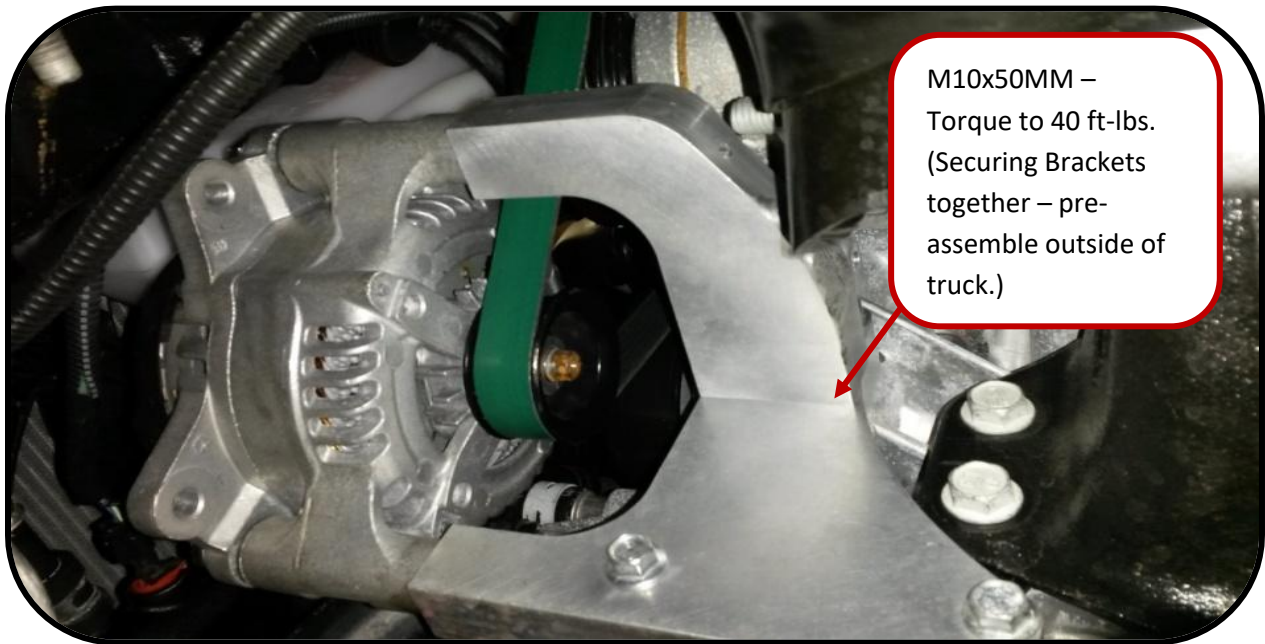

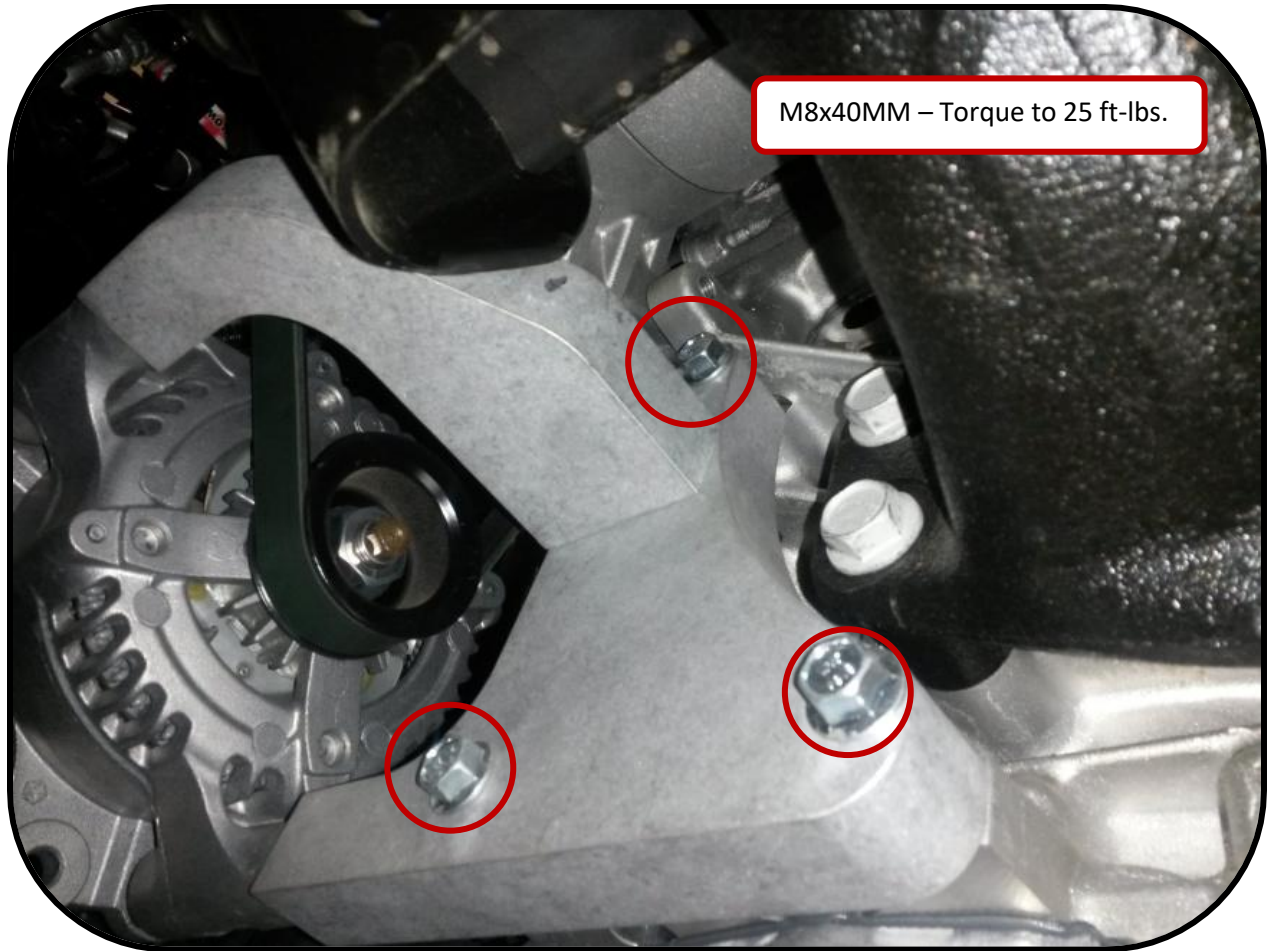

46. The alternator power wire and two control wires need to be extended to reach the new location of the alternator. First cut the factory alternator power wire and 2 control wires (with connector on end) 4" down from the T-Junction. Next strip the end of the wire cut above and insert the end into the supplied wire lug and tighten the set screw as shown below. Into the other end of the lug insert the supplied 3' alternator power extension wire, BE SURE to first slide the supplied heavy duty adhesive lined red heat shrink onto the extension first. Tighten the set screw on the other end of the lug that now holds the extension wire with ring tongue terminal on the end. Using a heat gun and supplied red heat shrink, seal the lug and wire creating a watertight sealed joint as shown below. The butt connectors supplied for the control wires are heat shrink solder connectors and do not need to be crimped but heated with a heat gun to melt the solder. To ease this process they can be **lightly** crimped to hold the wire as long as the outer plastic is not broken.

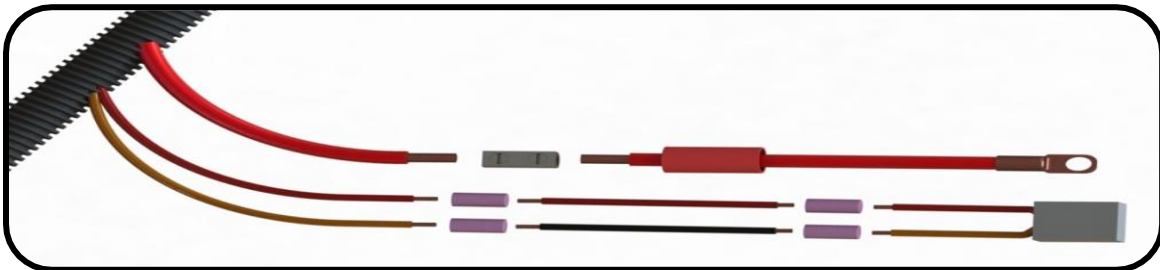



47. Remove the idler pulley from the factory alternator bracket and transfer it to the lower hole on the supercharger mounting plate as shown. Use the supplied 6MM spacer behind the idler and reuse the factory M10 idler bolt to mount it to the plate.



48. Next install the supplied serpentine belt as shown and route based on the supplied belt routing diagram sticker.

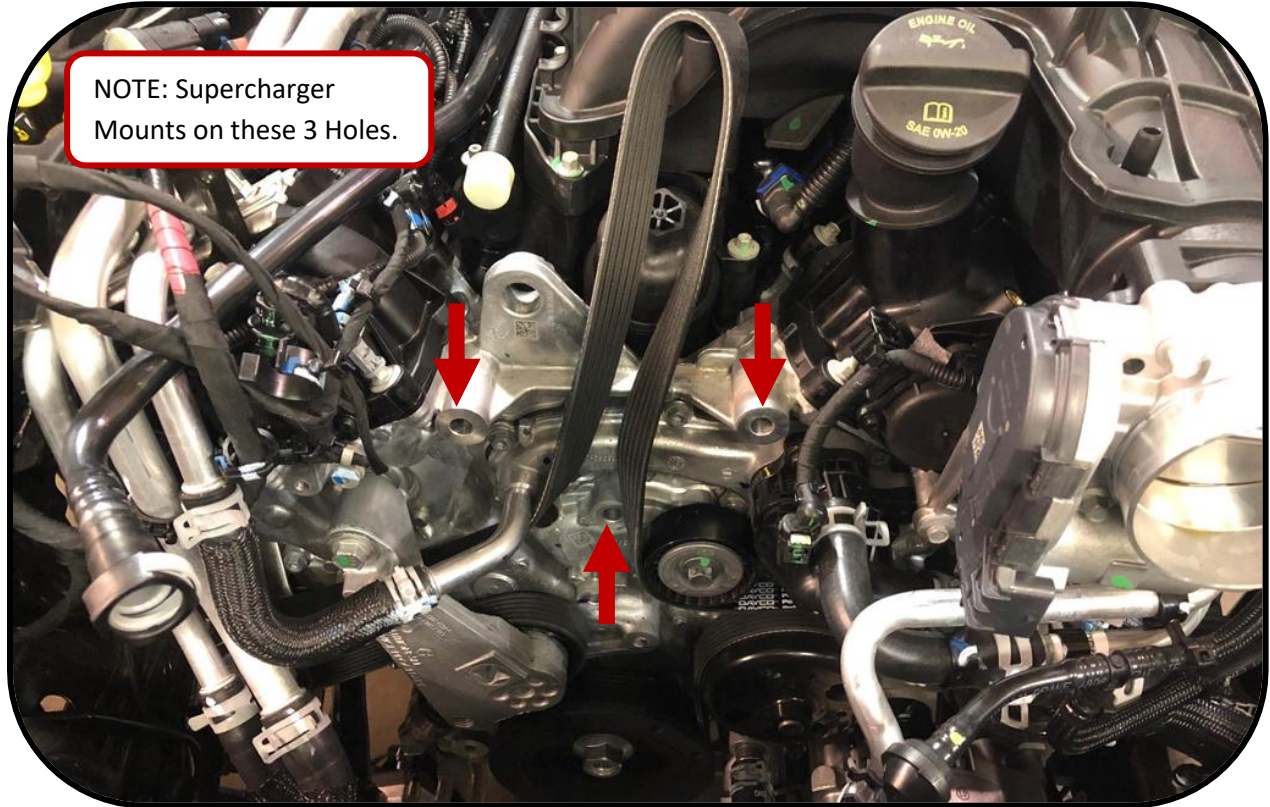

**HAMBURGER'S**  
SUPERCHARGERS

THE SUPERCHARGER OIL AND FILTER  
MUST BE CHANGED EVERY 24,000 MILES/38,000 KM  
OR TWO YEARS, WHICHEVER COMES FIRST.

P/N	DESCRIPTION	QTY
93055	MAINTENANCE KIT	1

**JEEP JK/JL S/C BELT ROUTING DIAGRAM**  
FOR TECHNICAL ASSISTANCE, PLEASE CALL (732)240-3696

49. Preassemble the supplied plate hardware and spacers, two of the three plate mounting spacers (RED) are the same; the single longest spacer (BLUE) is used on the lowest bolt as shown below. The GREEN spacer is the 6MM spacer used to mount the idler earlier.

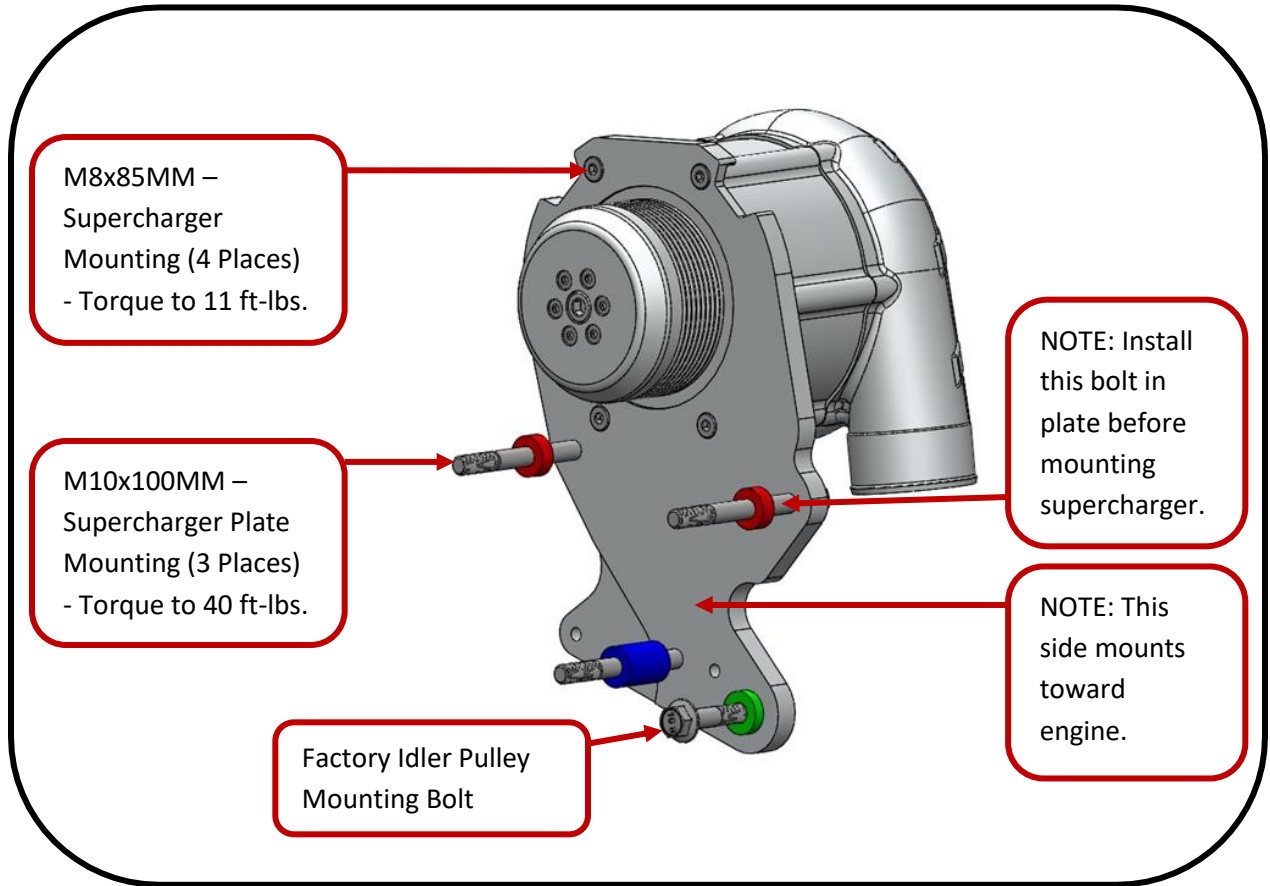

50. Preinstall the oil fittings on the supercharger using the supplied banjo bolts, barbed fittings, and two copper crush washers for each fitting. The banjo bolts must be torqued to 13 ft-lbs.
51. Mount the supercharger to the plate as shown and torque the socket head bolts to 11 ft-lbs (132in-lbs).



52. Install the assembly on the engine and torque all three M10 bolts to 40ft-lbs. See Figure above for mounting hole locations.

53. Reinstall the vacuum pump on the supercharger mounting plate using the supplied M8x16MM bolts and reconnect the vacuum pump hose and connector.

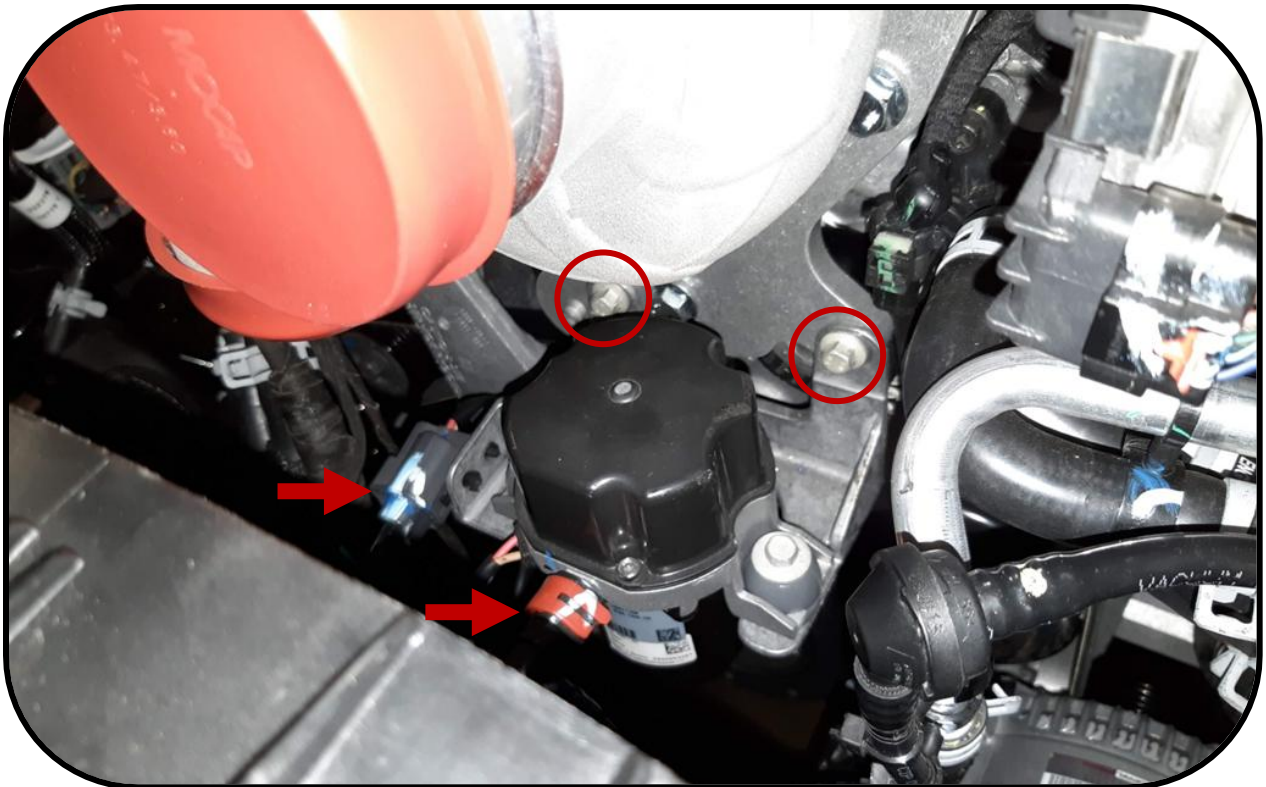

54. From the front of the vehicle remove the radiator support braces, plastic radiator air baffling, and air cleaner box fresh air supply duct. These components will not be reused.

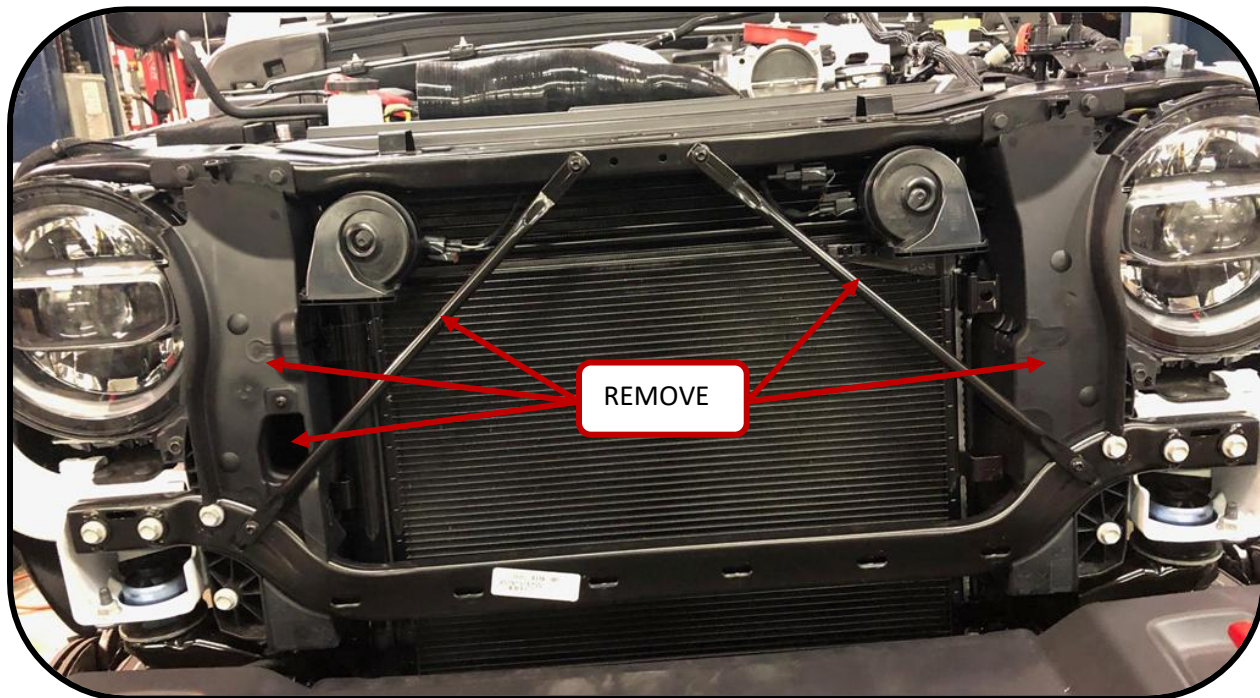



55. Both side of the plastic radiator support will need to be trimmed to make room for the charge tubes. See pictures below. You will need to test fit the tubes when trimming and ensure that at a rest the tubes are not rubbing on the radiator support or radiator. Grind down any sharp edges that are in contact.

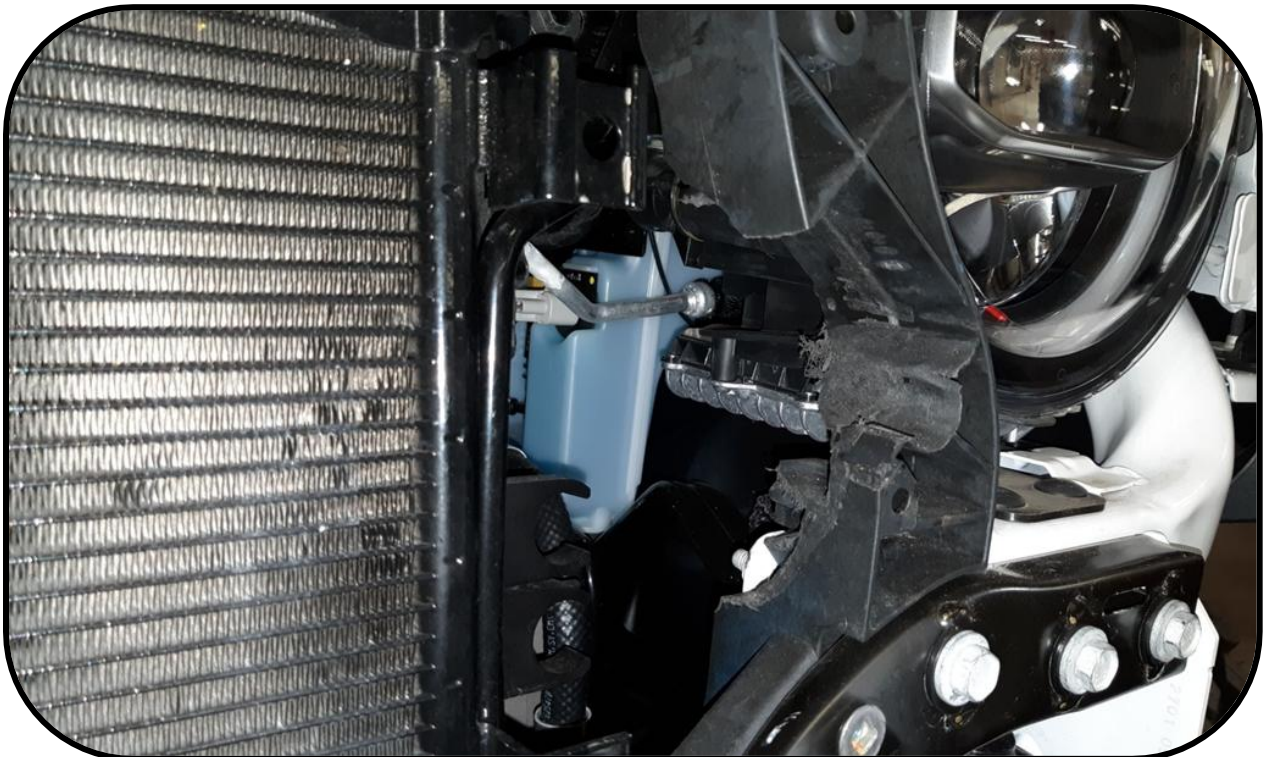
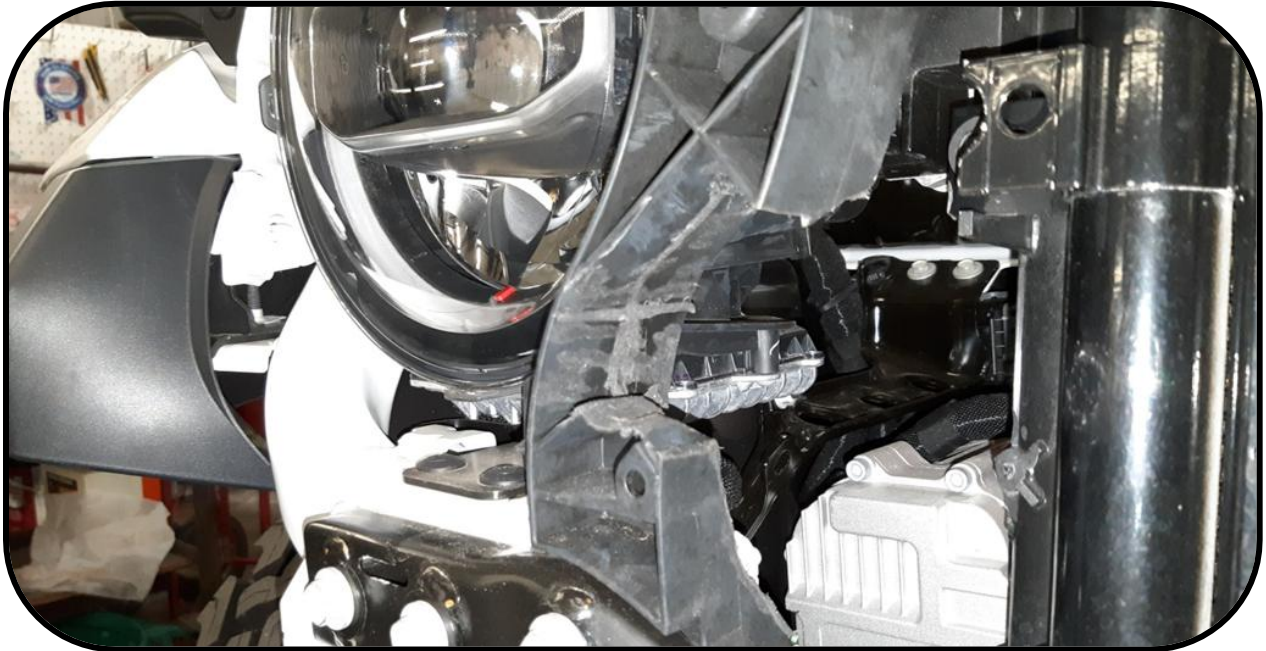

56. Utilize the figure below to aid in the following steps.

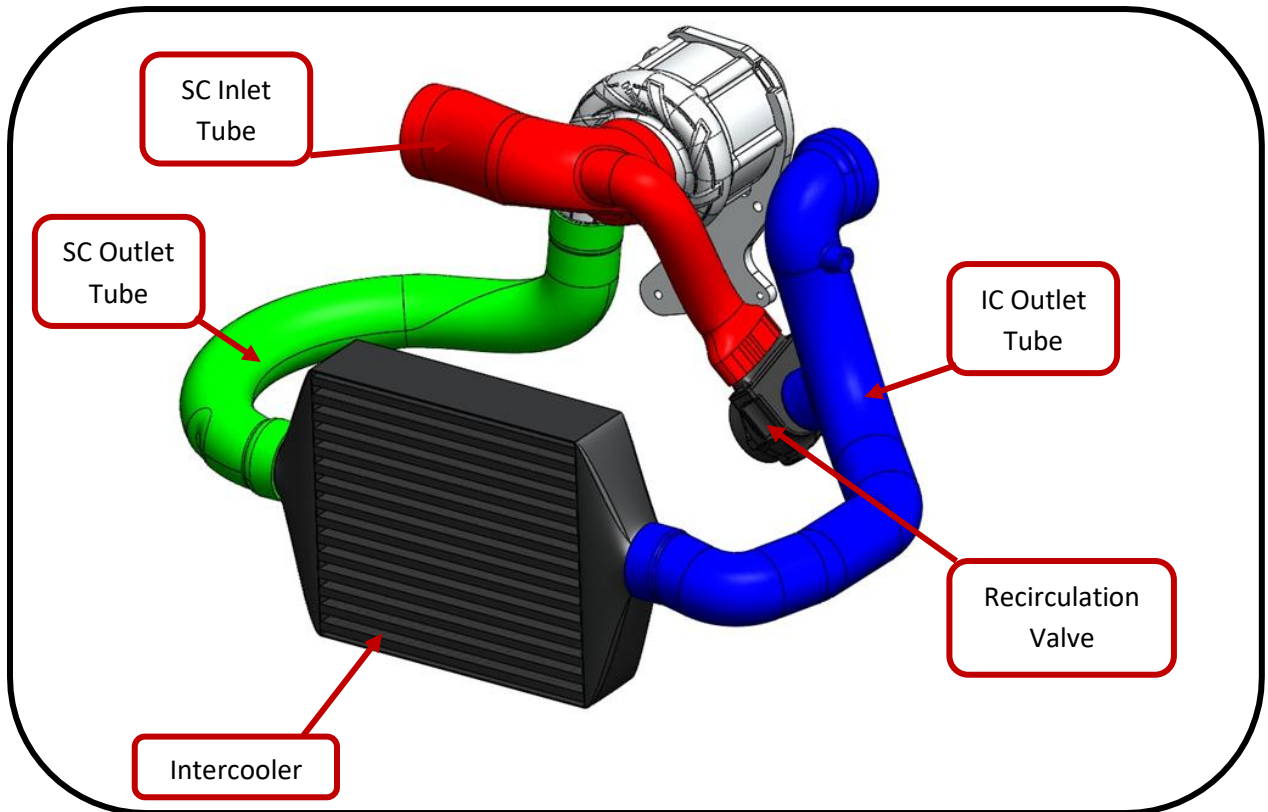

57. Next install the supercharger outlet tube as shown. Utilize the included 2.5" worm drive clamps to tighten to the supercharger.

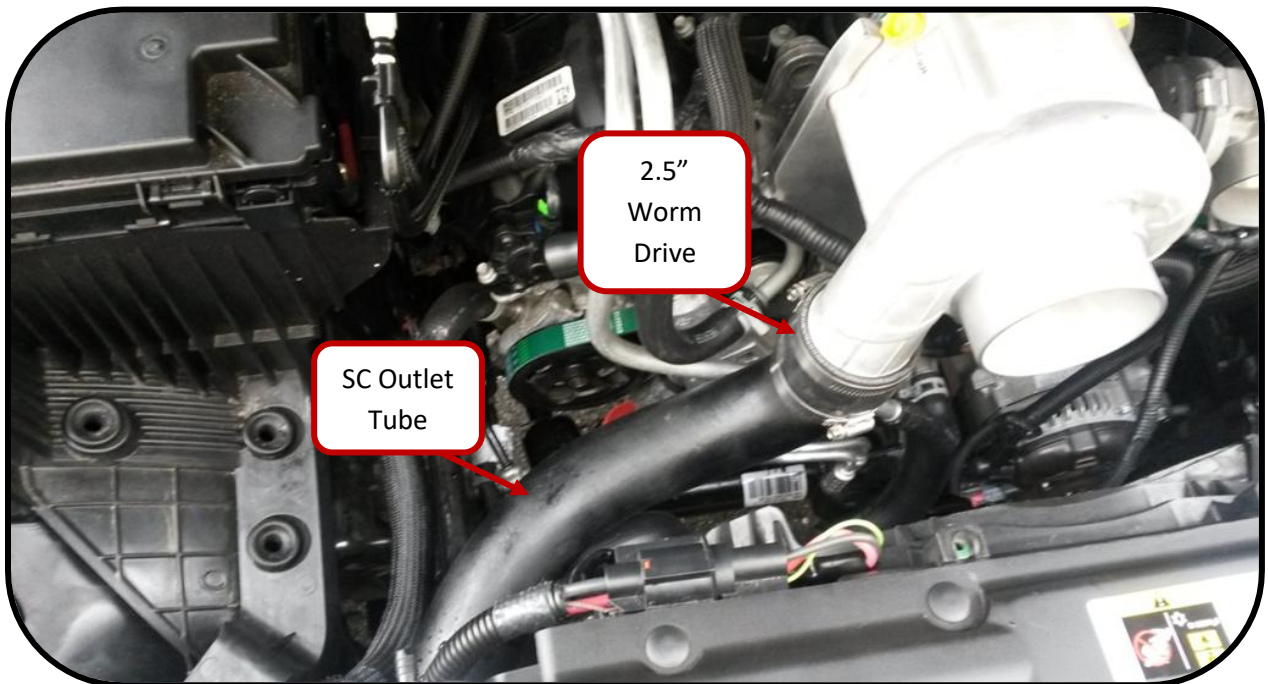

58. Now preassemble the intercooler outlet tube, supercharger intake tube, and recirculation valve as shown in the Figure above. Use the SAE36 worm drive clamps to tighten the tubes to the recirculation valve. Install the supplied banjo bolt and barbed fitting using the crush washers on the recirculation valve. Then install the assembly as shown. Use the supplied 3.5" T-Bolt clamp to secure the intercooler outlet tube to the throttle body. Leave the supercharger inlet tube off to the side for now and do not attach to the supercharger.

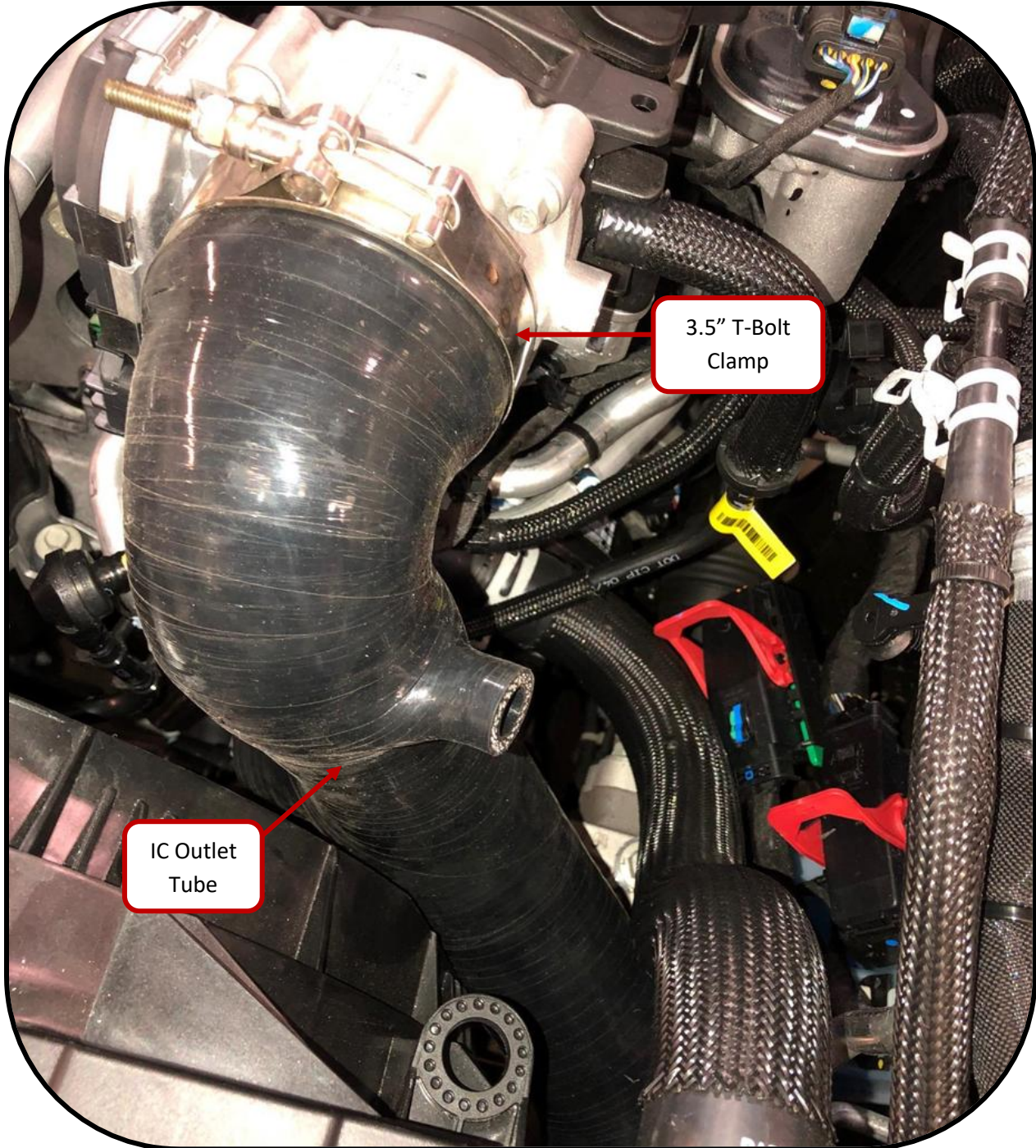

59. Next install the intercooler as shown. Install the supplied adhesive backed rubber strip on the bottom of the intercooler. The top bracket shown below is separate from the intercooler and is installed with double sided tape. Install this bracket on the intercooler after the inlet and outlet tubes are in place. Once in place install bracket with tape and bolt to radiator support using the factory T30 bolts used to secure the radiator support braces removed earlier.

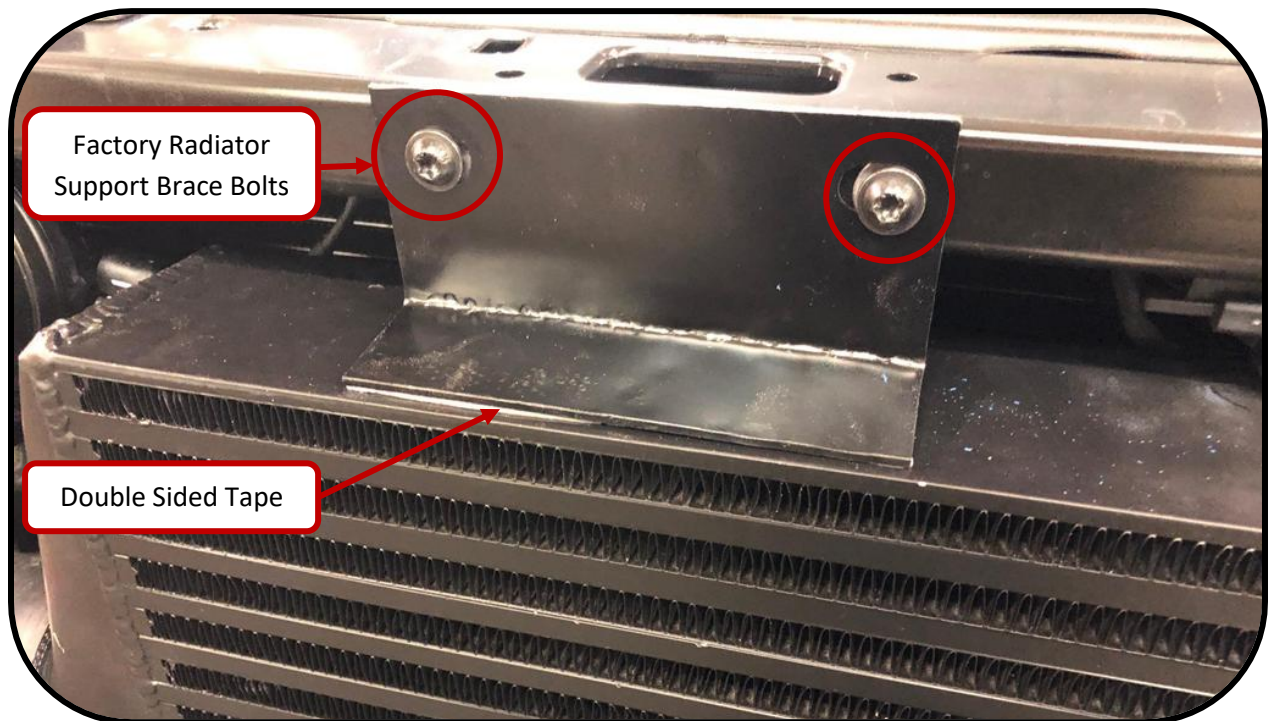
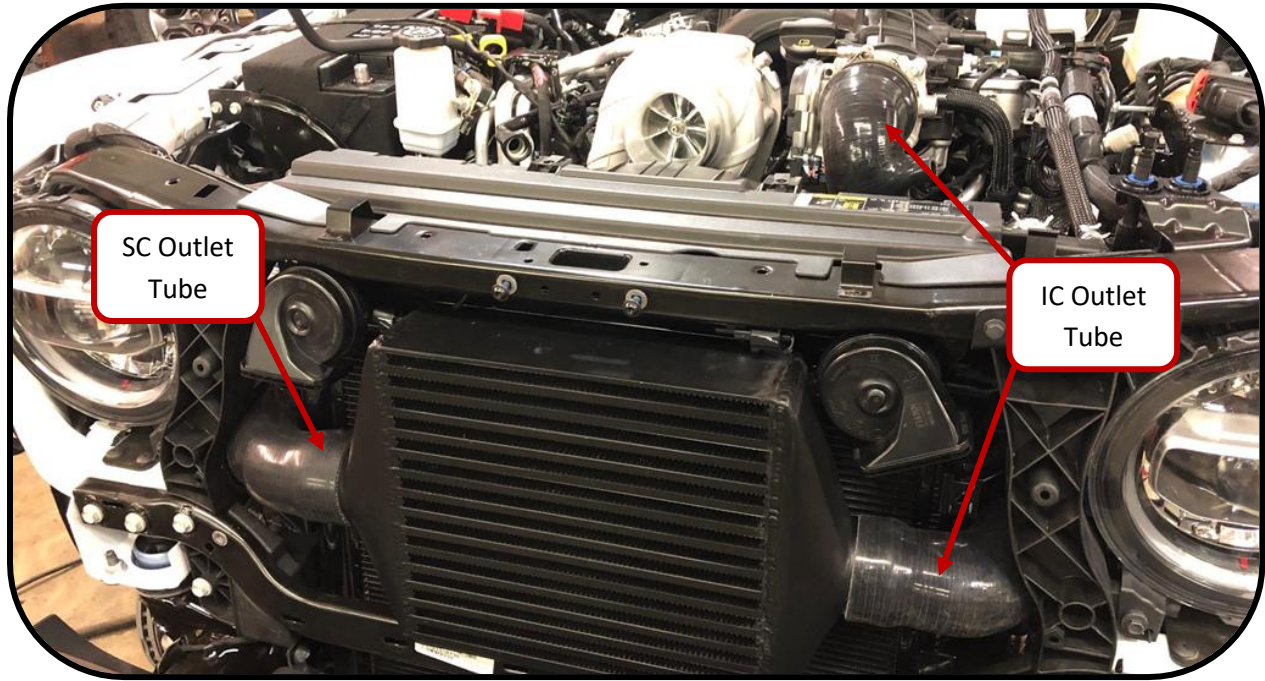

60. Secure the charge tubes to the intercooler using the remaining two 2.5" worm drive clamps.
61. Install the IAT sensor into the intercooler outlet tube using the SAE08 worm drive clamp to secure it. Then reconnect the wiring harness.

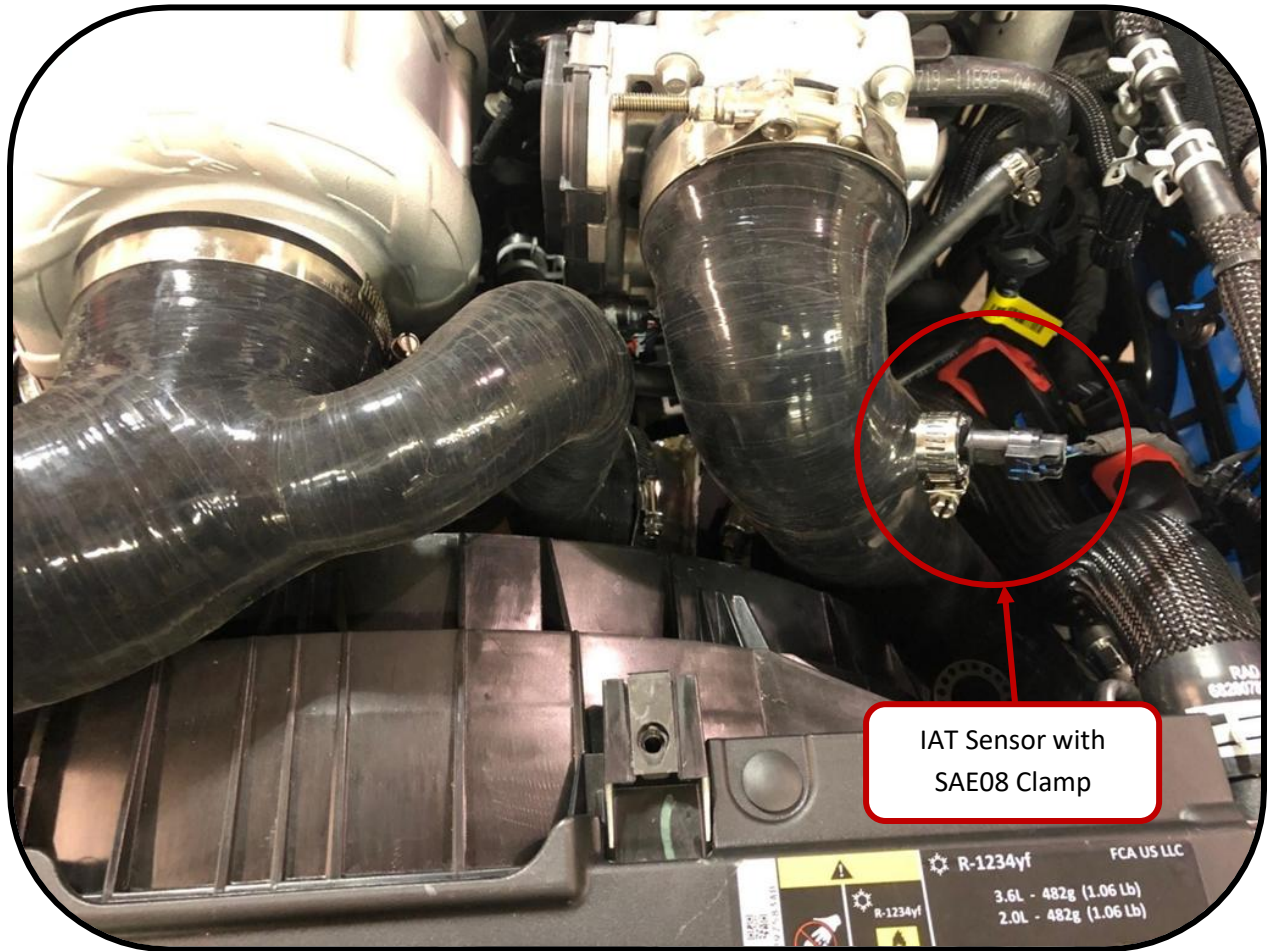

62. Next install the vacuum supply lines for the recirculation valve. Cut the factory brake booster vacuum supply hose and install the supplied 3/8x3/8x1/4 "T" as shown. Use the supplied 1/4 x 24" long vacuum hose to connect between the "T" and the recirculation valve barb fitting. Use the supplied hose clamps to secure all connections.

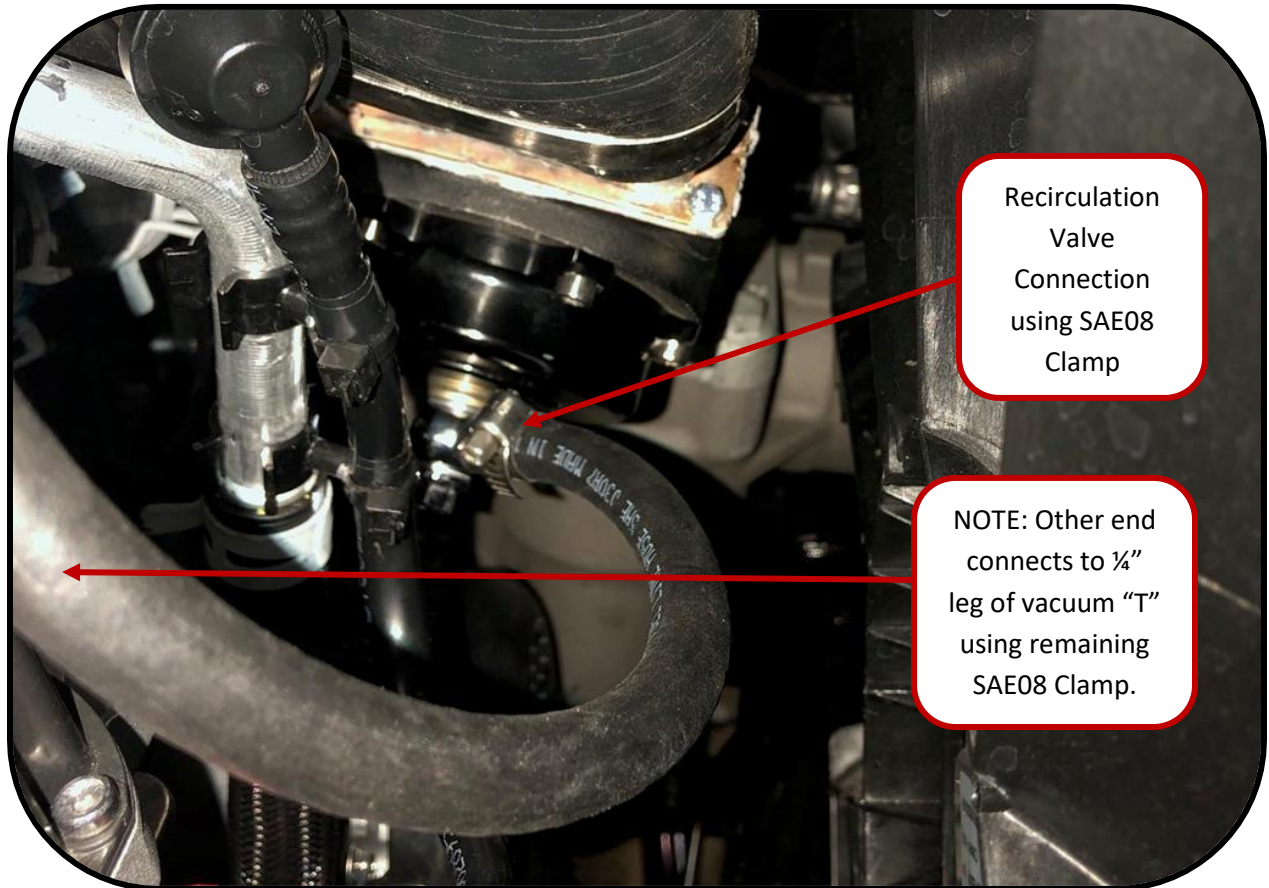
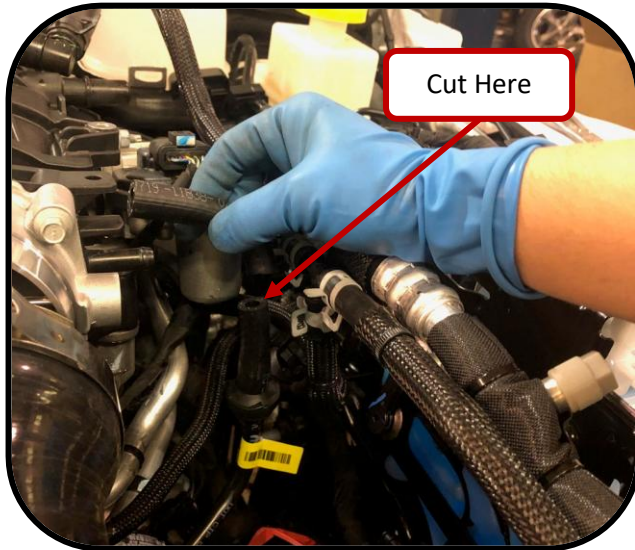

63. Next you will have to modify both of the crankcase breather hoses; start with the factory foul air tube which runs from the back of the PS cylinder head to the top of the Intake Manifold. Cut both quick connect ends off of the factory hard tube and assemble the new hose as shown using the precut 5/8"x6" PCV hose, 5/8"x27" PCV hose, the supplied check valve, and the 24MM Constant Tension Clamps. Note the direction of the check valve, see photos below. Reinstall the new foul air hose.

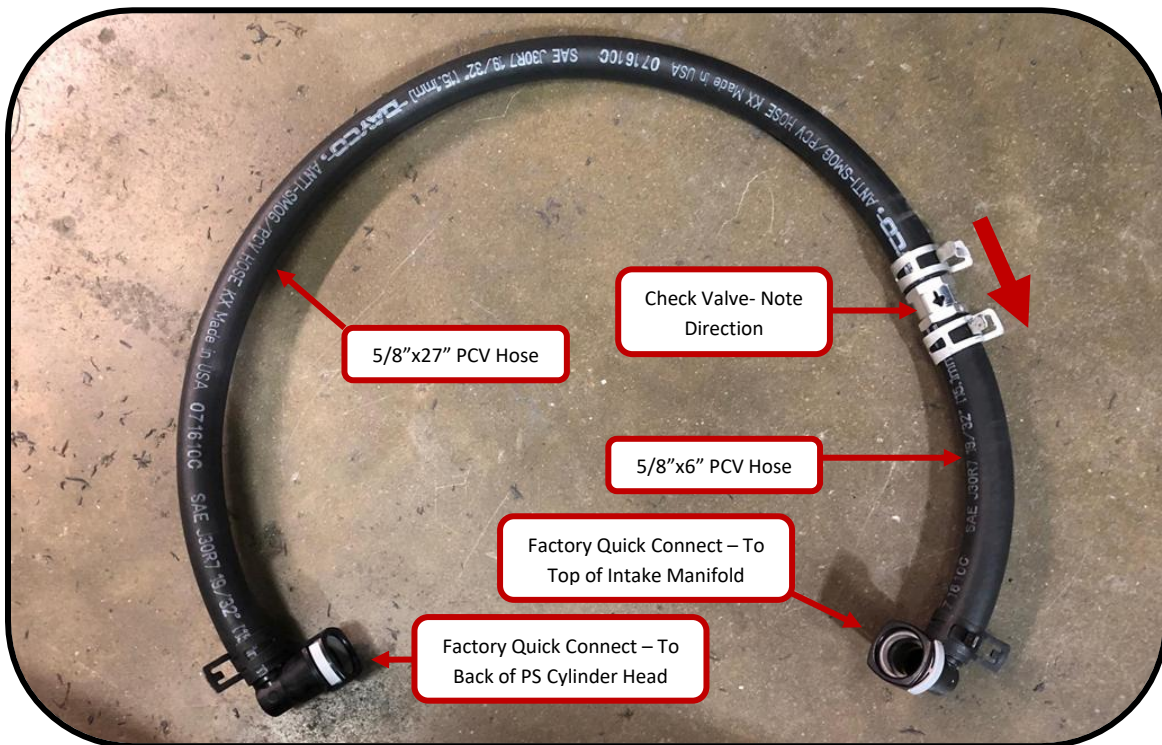
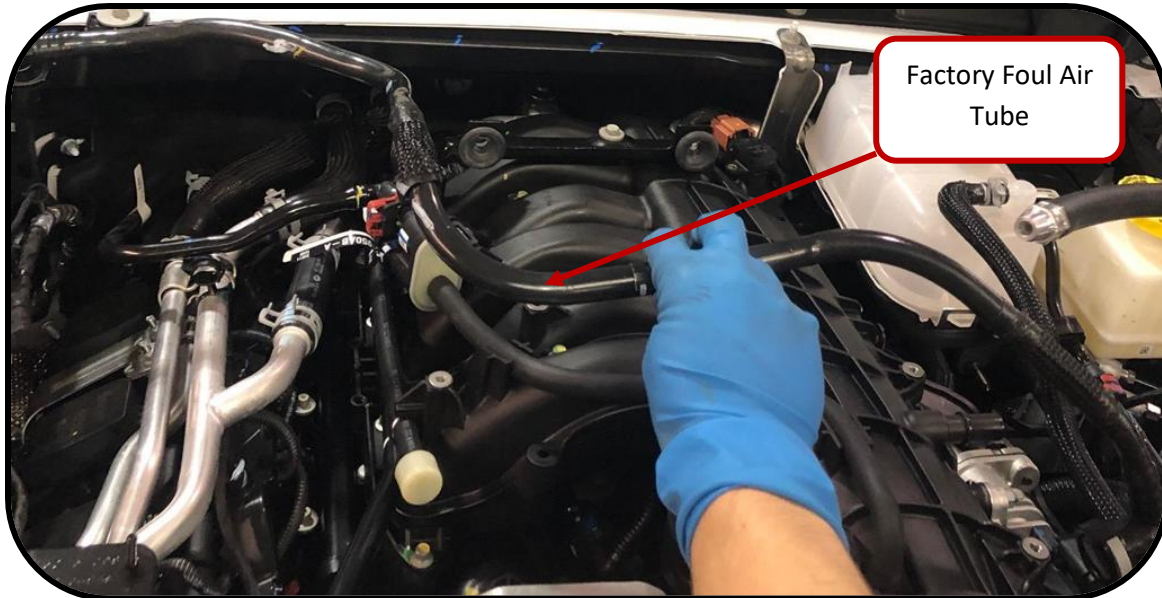



64. Next modify the factory fresh air tube which runs from the back of the DS cylinder head to the factory intake air tube. For this hose you will only need the 90° quick connect fitting that attaches to the back of the DS cylinder head. Assemble the hose using the 5/8"x33" PCV hose, 5/8"x5/8" barb fitting, and the remaining two 24MM constant tension clamps. See photos below. Reinstall the new fresh air hose.

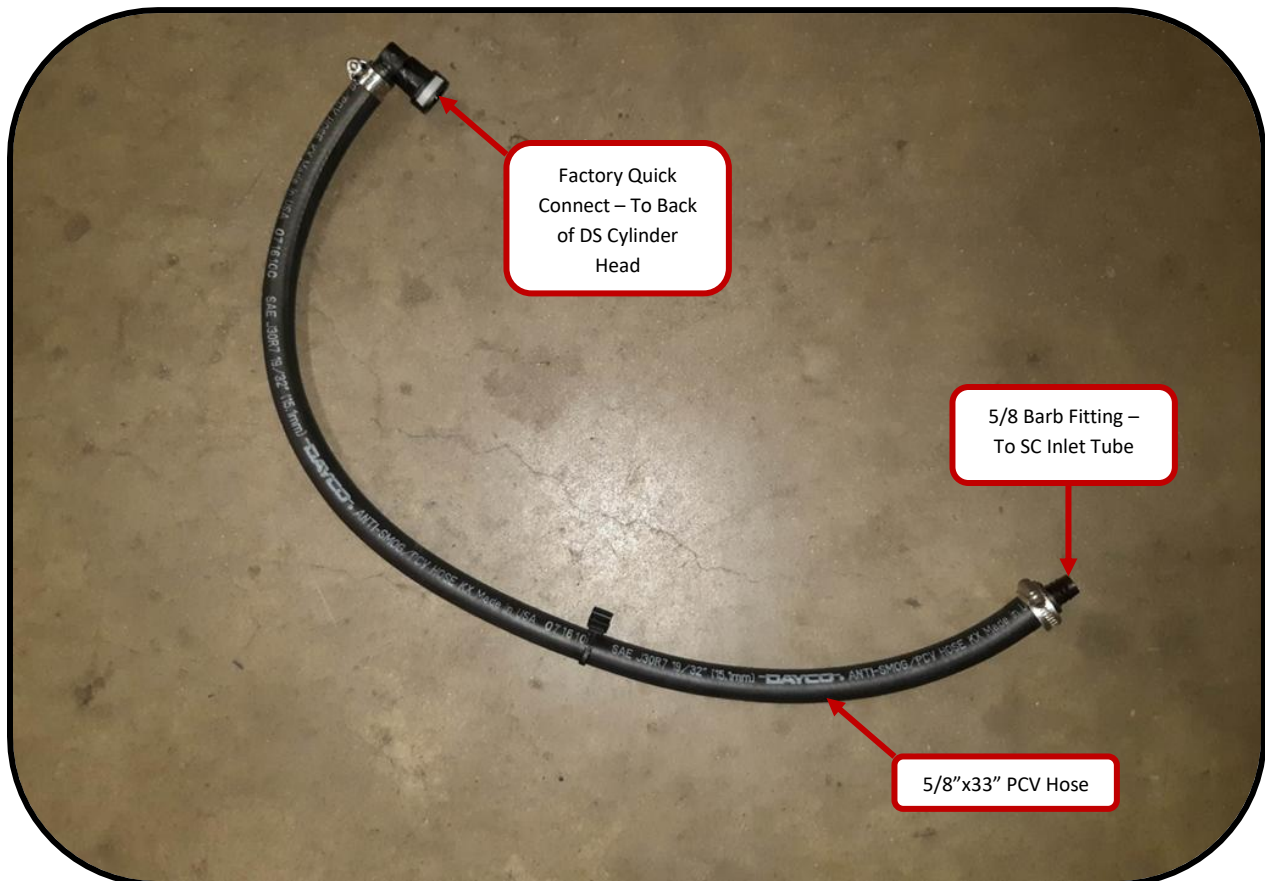





65. Next assemble the supercharger oil cooler. First install the supplied 90° oil cooler fittings; use a drop of oil on the threads to ease installation. Both fittings should face the driver's side of the vehicle. Tighten until the fittings begin to turn, then hold the fitting in the approximate position and tighten the nut another half turn. Upon start up you will need to check these fittings for leaks, if any leaks exist tighten until the leak stops.
66. Then mount the two electric cooling fans to the fan shroud using the eight plastic screws. The screws will be installed from the back of the shroud, see photo.
67. Mount the cooling fan assembly to the oil cooler using the supplied M6 hardware. Also mount the oil cooler mounting brackets to the top of the cooler/shroud assembly using the same hardware, see photo.

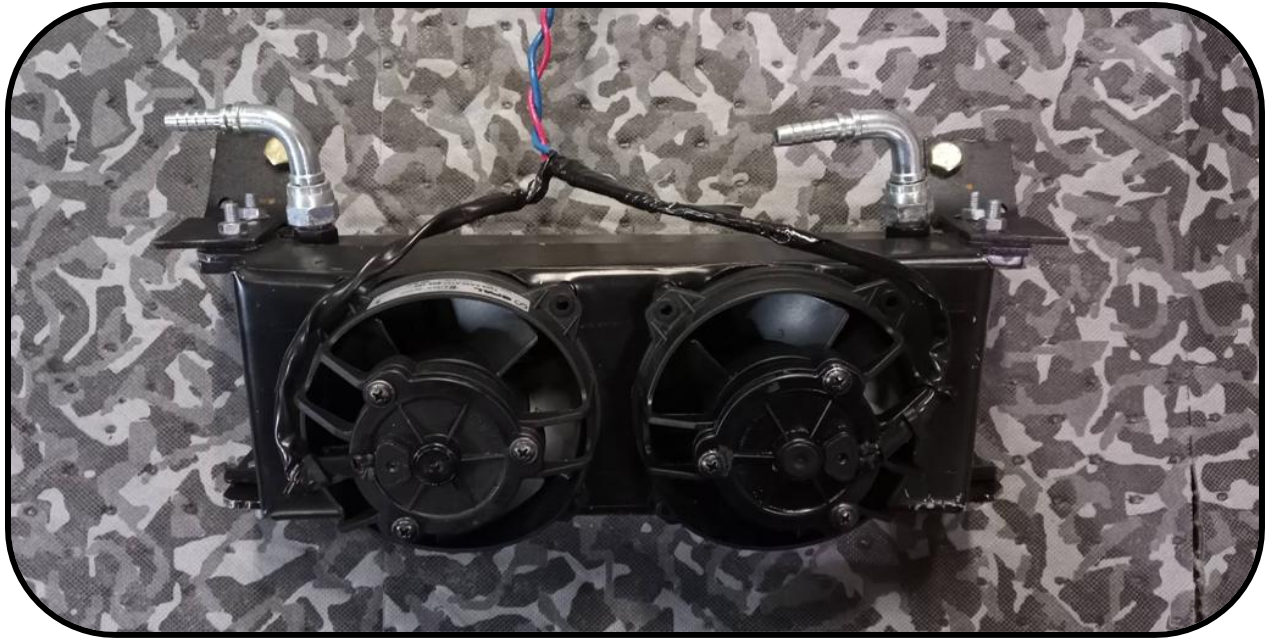

68. Next mount the oil cooler and fan assembly. The assembly will be mounted to the rear side of the front bumper cross beam, see photos. You will need to position the cooler with brackets and mark the holes that need to be drilled for the brackets. Use the supplied M8 hardware to mount the oil cooler once drilled.

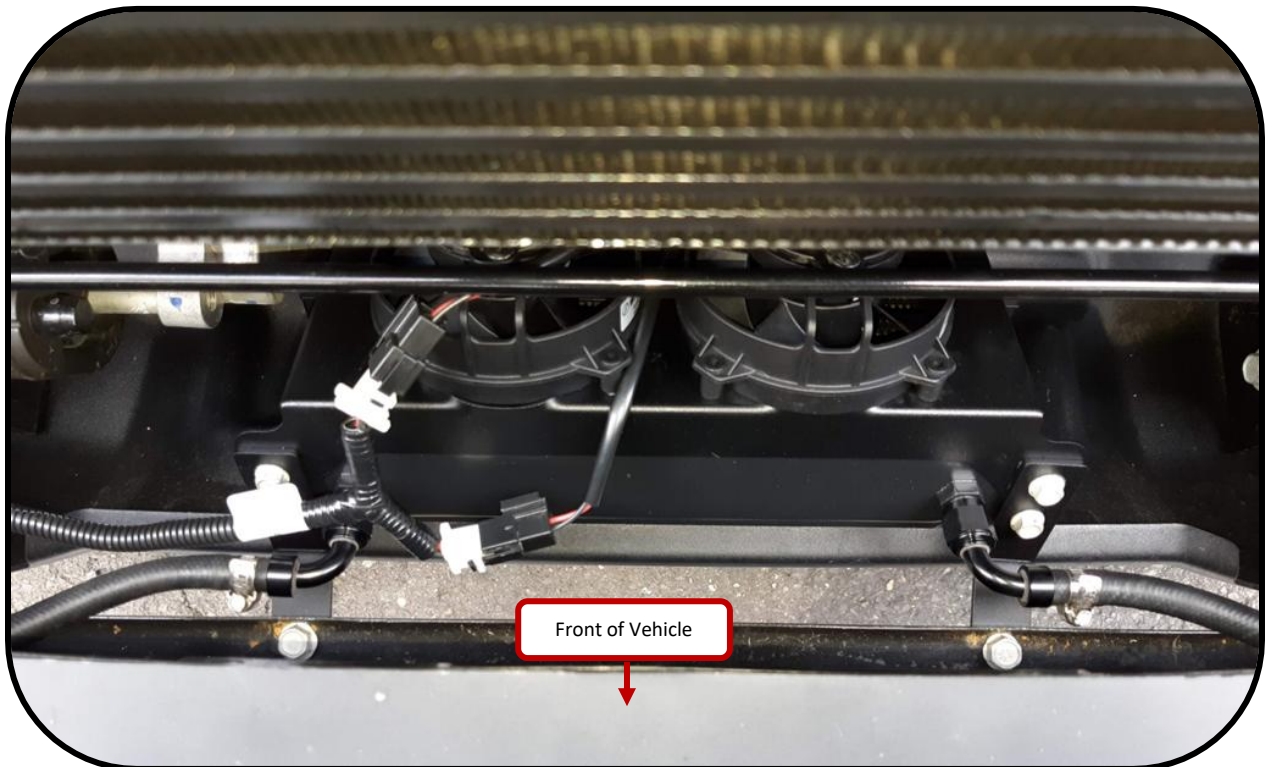

69. Now use the supplied wiring harness to power the fans. Run the harness through the engine bay from the fans to the under hood fuse box. The fuse tap on the harness will be installed in fuse location F50 (10A Accessory Fuse), cut a small notch in the side of the box to pass the wire through. On the same end of the harness is the ground lug which will be installed on the passenger side inner fender ground lugs, which were disconnected in the beginning of the install. Connect this lug when you reconnect the factory grounds later. See photos.

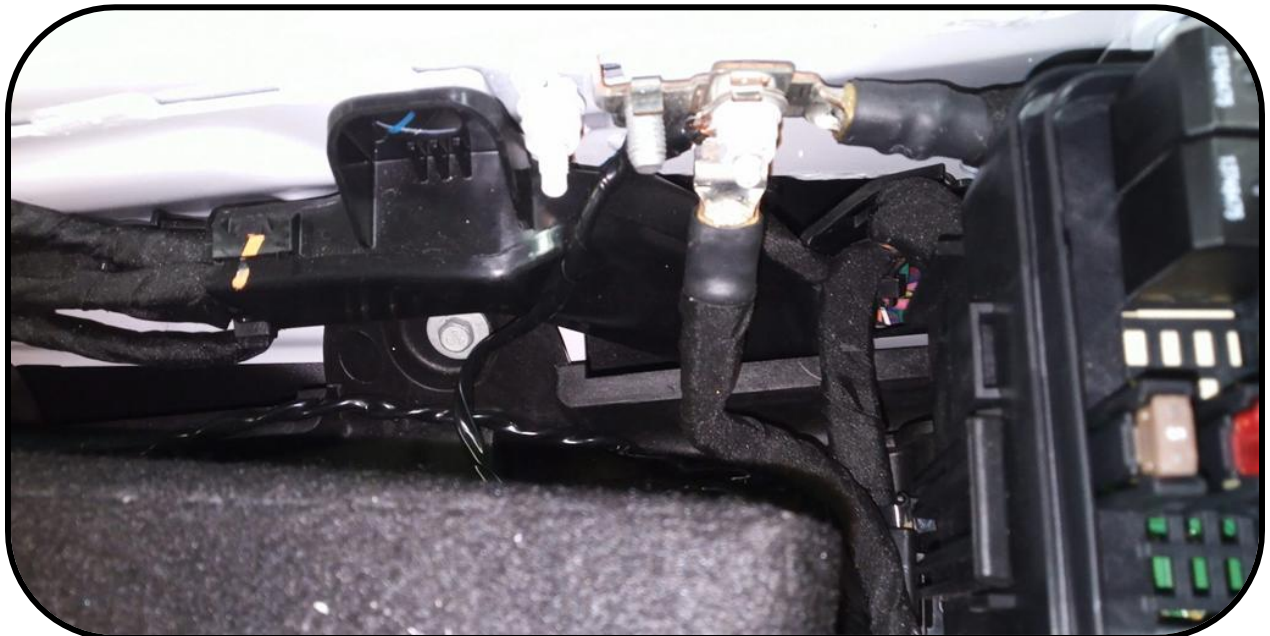
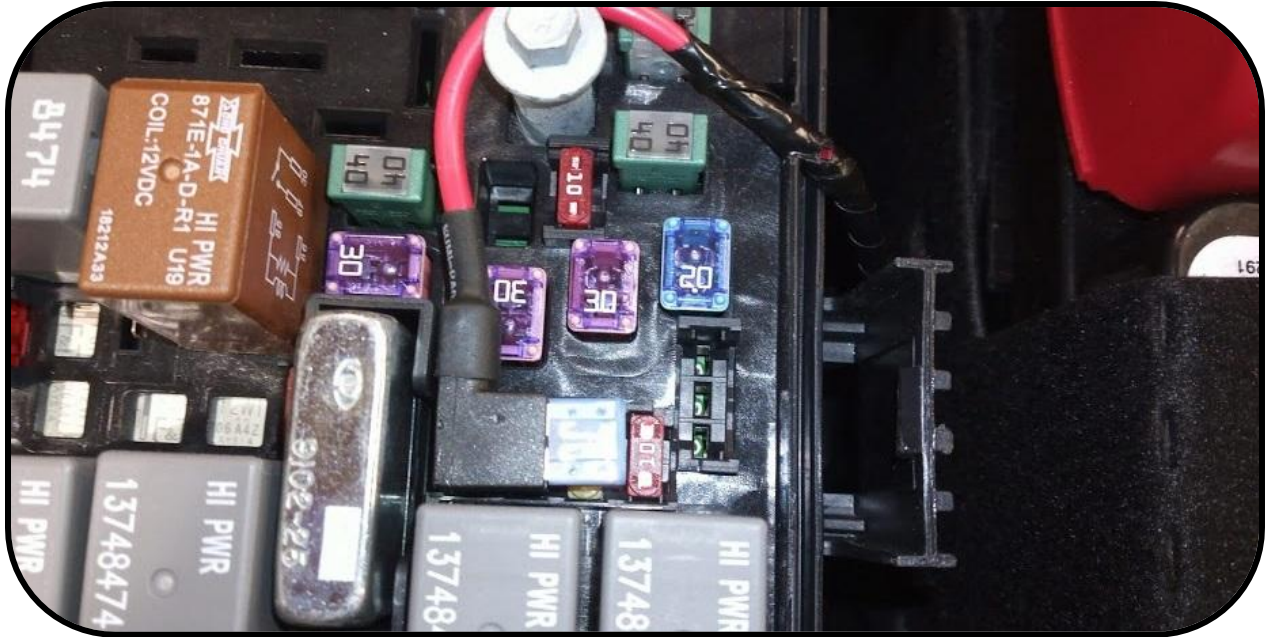

70. Next mount the supercharger oil reservoir. The oil reservoir is mounted to the DS inner fender. First install the banjo bolts, barb fittings, and crush washers onto the oil reservoir. Then install the 5/16"x8" oil hose and oil filter to the bottom fitting on the oil reservoir. Install the 5/16"x42" oil hose on the other side of the oil filter. Use the supplied worm drive clamps to secure the hose ends. Note the direction arrow on the oil filter and confirm that the direction is correct.

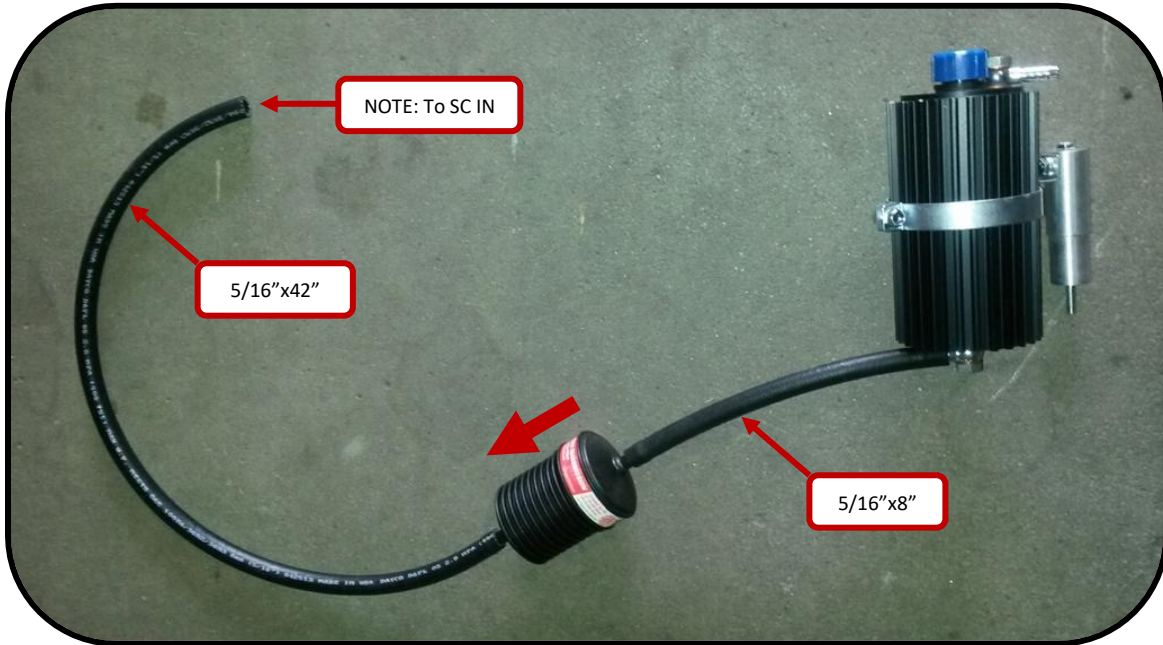

71. Next install the oil reservoir bracket on the driver side inner fender as shown using the M6x30MM bolt. Then using the two 3.25" loop clamps, two M6x12MM bolts, and two M6 Nylock nuts; mount the oil reservoir assembly onto the bracket using the loop clamps.



72. Next use the diagram below to plumb the oil loop for the supercharger. Use the supplied worm drive clamps to secure all hose ends, used the supplied cable ties to ensure that no hoses will be chaffed or rubbed.

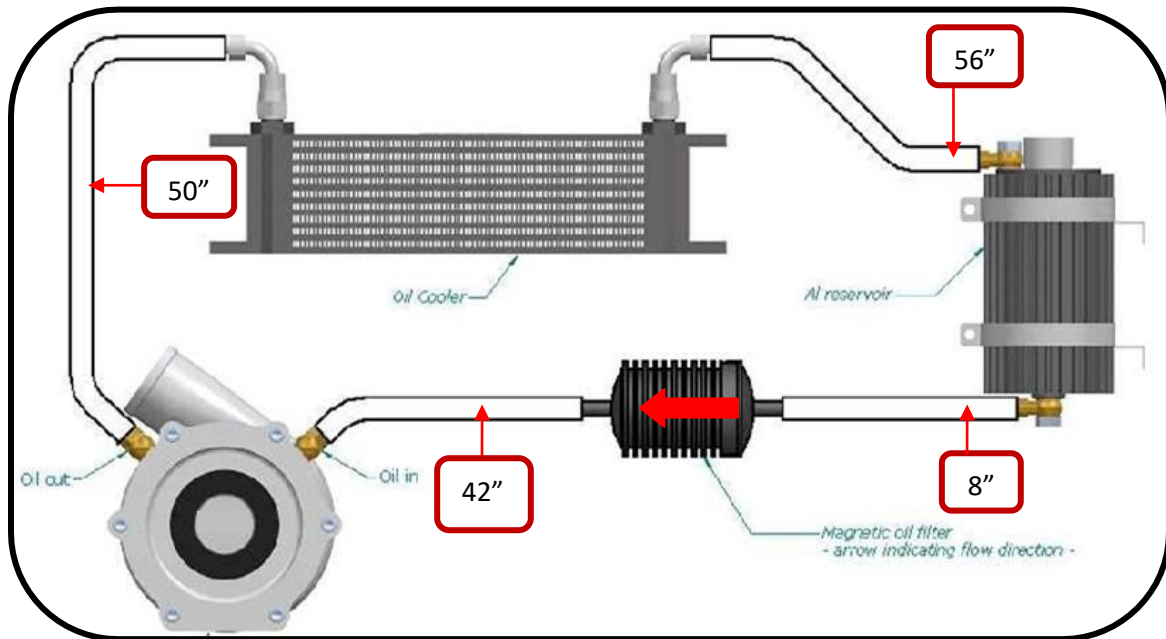

SC Out to Cooler In	50"
Cooler Out to Reservoir In	56"
Reservoir Out to Filter In	8"
Filter Out to SC In	42"

73. Next the stock air cleaner housing lower section needs to be modified for clearance on the supercharger outlet tube. The bottom of the box needs to be cut open as shown below. Use a pneumatic cutoff wheel to open the bottom of the box as shown below.



74. Once the stock box has been modified it can be installed into the vehicle using the factory bolt to secure it.
75. Next install the SC to air box tube as shown below and in “grey” above. Utilize the supplied worm drive clamps to secure to the SC and the air box.



76. Reinstall the front grill, lower grill shroud, skid plate, and engine cover.
77. Re-Install the tuned PCM that was returned to you from Hamburgers Superchargers Inc.
78. Reconnect battery and inner fender grounds.
79. Fill the SC oil loop: **You will use 3/4 to 7/8 of the bottle of oil included in this kit. See procedure below.**
80. Use the supplied cable ties to locate any electrical harnesses/vacuum hoses/oil hoses away from any moving parts and avoid chaffing.
81. Install the supplied Octane sticker onto the gas cap. Install the supplied Belt Routing Sticker under the hood. Install the red DLC cover to prevent accidental re-flashing.

82. Install the Gateway Bypass harness underneath the dash near the OBDII connector as shown.





## Initial start up after Oil Change/Oil Fill

To ensure proper traction fluid circulation and adequate lubrication, it is important to prime the oil system before the engine is started for the first time and after the oil change/oil fill.

1. Carefully fill the oil canister with traction fluid without exceeding the maximum mark on the dip stick. The oil level is measured with the thread of the dip stick cap fully engaged
2. The banjo bolt at the oil line attached to the supercharger inlet marked "oil inlet" should be loosened a couple of turns allowing air to escape the system
3. **Carefully** apply pressurized air to the oil filler hole at the top of the canister. **Do not pressurize the system to more than 10psi.** Use a rag or a sponge as a seal between the air gun and the canister
4. When oil appears at the "oil inlet" with no signs of air, tighten the banjo bolt and the system is primed
5. Carefully top up the oil canister to the maximum mark on the dip stick
6. Turn on the engine and rev it to 2000-3000 rpm and make sure the oil starts flowing by visual inspection, looking into the oil canister. Do not rev the engine more than specified as this can cause damage to the supercharger. **MAKE SURE THE RESERVOIR DOES NOT EMPTY DURING THIS STEP OR AIR WILL BE INTRODUCED INTO THE SYSTEM AND DAMAGE WILL OCCUR. IF IT DOES START TO EMPTY POUR MORE FLUID IN. UTILIZE AT LEAST ¾ OF THE SUPPLIED BOTTLE OF FLUID TO PRIME AND FILL THE SYSTEM.**
7. Let the engine idle for 5 minutes while checking the oil system for leaks.
8. The supercharger traction oil and filter **MUST** be changed every 2 years or 24,000 miles, whichever occurs first or you **WILL VOID YOUR WARRANTY** and failure is likely to occur.
9. Check the oil level periodically using the correct procedure

<i>Hamburgers Superchargers Part Number</i>	<i>Description</i>	<i>QTY Required</i>
906822102	Supercharger Oil (1L)	1
210326512	Magnetic Oil Filter	1

**The installation is now complete.**